

seca 515/514

Instructions for use for doctors and assistants

Software version 1.1

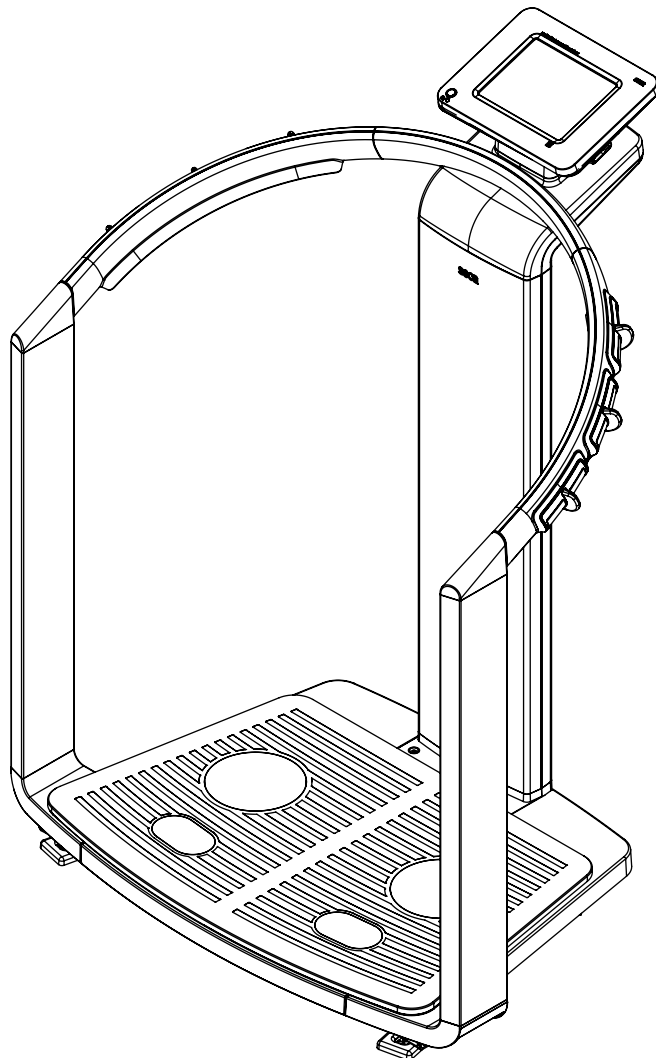

CONTENTS

1. Device description	4	Activating/deactivating pre-tare function.	29
1.1 Intended use	4	Entering height manually.	29
1.2 Description of function.	4	Transmitting height via seca 360° wireless network	29
Recording weight and height	4	Calculating BMI automatically	30
Bioimpedance measurement	4	Switching weighing range automatically	30
Management of patient data.	4	Printing partial results	30
Analysis	4	5.3 Performing a bioimpedance measurement	31
Management of user data.	5	Switching on the device	31
Data transmission and network functions	5	Determining weight and height	31
Compatibility	5	Checking module selection.	31
1.3 User qualification	5	Starting measurement	32
Administration/network connection.	5	Entering PAL value and waist circumference ..	35
Measuring mode	5	Printing partial results	36
1.4 Contraindications.	6	5.4 Assigning a measurement to a patient file	36
2. Safety information	7	Checking data connection	36
2.1 Safety rules in the instructions for use	7	Logging on to a seca patient database.	36
2.2 Basic safety information.	7	Searching for a seca patient file.	37
Handling the device	7	Providing a seca patient file from the PC software	39
Preventing electric shock	8	Creating a new seca patient file	40
Preventing injuries and infections	8	Editing patient data	41
Preventing device damage	8	5.5 Viewing analyses	42
Dealing with measuring results	9	5.6 Closing the measuring procedure	43
Dealing with packaging.	10	Saving the measured results.	43
3. Overview	11	Printing results report	44
3.1 Controls	11	Logging off from a seca patient database.	44
3.2 Symbols in the start display.	13	6. Medical basis	45
3.3 Color symbols and other controls	15	6.1 Bioimpedance analysis (BIA)	45
3.4 Identification on the device and the type plate ..	16	Classic body composition analysis	45
3.5 Identification on the packaging	17	Functional principle of bioimpedance analysis. .	46
4. Before you really get started	18	Pioneering achievement: seca formulas	46
4.1 Scope of delivery.	18	6.2 Evaluation parameters	47
4.2 Establishing power supply.	19	Summary of evaluation parameters	47
4.3 Setting up the device.	19	seca specialty: co-ordinate system with tolerance ellipses	49
4.4 Configuring the device.	20	6.3 Evaluation modules	50
4.5 Operating the device in a PC network	20	Development/growth	50
Connecting the network via Ethernet or seca 360° wireless network	20	Energy	53
Printing	21	Function/rehabilitation	54
Indirect connection via USB memory stick	21	Fluid	56
4.6 Operation using a seca 360° length measuring device	22	Health risk	57
5. Operation	23	Raw data for impedance	59
5.1 Operating concept.	23	6.4 References	60
Swiveling the touchscreen display	23	7. Configuring the device.	61
Switching on the device	23	7.1 Adapting default module selection for bioimpedance analysis	61
Selecting functions	23	Showing/hiding default module selection	61
Selecting extended functions	24	Creating default module selection.	62
Entering text	24	7.2 Saving settings	63
Display special characters	25	Applying settings	63
Entering numbers	25	Exiting Settings\user menu	63
Measuring procedure	26	8. Hygiene treatment	64
Automatic standby	26	8.1 Cleaning	64
Switching off the device	26	8.2 Disinfecting	64
5.2 Determining weight and height	27	8.3 Sterilizing	64
Starting the weighing procedure.	27	9. Function check	65
Manually determining hold value (hold)	28	10. Maintenance/subsequent verification (verified model)	65
Taring off additional weight (tare)	28		
Permanently storing additional weight (pre-tare)	28		

10.1 Information on maintenance and subsequent verification	65	13. Technical data	71
10.2 Checking the contents of the verification counter	65	13.1 General technical data	71
11. Maintenance (unverified model)	66	13.2 Technical data, bioimpedance analysis	72
12. Troubleshooting	67	13.3 Weighing data (verified model)	73
12.1 Power supply and display	67	13.4 Weighing data (unverified model)	73
12.2 Height and weight	67	13.5 Technical modifications	74
12.3 Bioimpedance analysis	68	14. Optional accessories	74
12.4 Data transmission	69	15. Spare parts	74
12.5 Printing	70	16. Disposal	74
		17. Warranty	75
		18. Declaration of conformity	75

1. DEVICE DESCRIPTION

1.1 Intended use

The Medical Body Composition Analyzer **seca 515/514** is mainly used in hospitals, medical practices and inpatient care facilities in accordance with national regulations. The **seca 515/514** device records weight, height and bioelectric impedance measurements and derivable parameters, e.g. fat-free mass (FFM), for automatic calculation. The results are displayed graphically and assist the attending physician with the following medical issues:

- determining energy expenditure and energy reserves as a basis for nutritional advice
- assessing metabolic activity and the success of a training program, e.g. within the framework of rehabilitation or physiotherapy
- determining a patient's fluids status
- determining general state of health or, in the case of a previously-known disease, assessing severity

The **seca 515/514** is **not** a diagnostic device. To make an accurate diagnosis, in addition to the results of the **seca 515/514**, targeted examinations have to be ordered by the physician and their results taken into account.

1.2 Description of function

Recording weight and height

The device uses an electronic scale. Weight is recorded across 4 load cells. Height is recorded via manual entry or via wireless transmission from a **seca 360°** length measuring device.

Bioimpedance measurement

Bioimpedance is measured according to the 8-point method. The flow of the low alternating current and the measurement of impedance are performed for each side of the body using a pair of foot electrodes and three pairs of hand electrodes. The hand electrodes are attached at different heights so that persons with a height of between 1.60 m and 2.0 m can adopt the ideal position on the device for a bioimpedance measurement.

Management of patient data

seca patient files can be created directly on the device to manage measured results. The seca patient files are stored in the patient database of the **seca analytics 115** PC software supplied. Alternatively, seca patient files can also be saved on the USB memory stick supplied. The USB memory stick likewise contains a seca patient database.

seca patient files and seca patient databases contain exclusively data necessary for working with seca products or determined using seca products. seca patient files can be managed and edited only using the **seca 115** PC software. The export and import functions of the **seca 115** PC software can be used for exchanging data with surgery and hospital information systems.

Analysis

Bioimpedance measurements are analyzed in graphical form based on scientifically-established formulas. In-house studies by seca established formulas for determining the parameters of total body water (TBW), extracellular water (ECW), fat-free mass (FFM) and skeletal muscle mass (SMM) for arms, legs, torso and whole body. In the same studies, in-house reference values were determined for the the following parameters in order to be able to show normal ranges: bioelectric impedance vector analysis (BIVA), mass indices (FMI, FFM), phase angle (ϕ). Further information is available in the section entitled "Medical basis" from page 45.

Management of user data Access data for users of the device are managed in the **seca 115** PC software supplied. In the course of the creation of user accounts for the **seca 115**, a user PIN is automatically generated for the **seca 515/514**.

The device can only be configured with administrator rights. An initial administrator PIN for the device is provided. It can only be changed on the device.

The creation and management of user data is thus only necessary if the seca patient database of the **seca 115** PC software is to be accessed using the device.

Data transmission and network functions The device is networkable. The network connection allows the device to use both the seca patient database and the special print function of the **seca 115** PC software.

The special print function of the **seca 115** PC software makes it possible to start printing out a detailed results report directly on the Medical Body Composition Analyzer **seca 515/514**.

Alternatively to the Ethernet link, seca mBCAs and the **seca 115** PC software can communicate wirelessly via **seca 360°** technology. For this purpose, the **seca 360° wireless USB adapter 456** (included in the scope of delivery) must be connected to a PC on which at least the application software of the **seca 115** is installed.

seca 360° length measuring devices can wirelessly transmit measured results to the device.

The device has the following interfaces:

- on the weighing platform
 - network connection (Ethernet)
- on the touchscreen display
 - internal seca wireless module
 - USB interface for connecting a USB memory stick (contained in the scope of delivery)

Compatibility This device (software version 1.1) is compatible only with version 1.4 of the **seca 115** PC software. There is no downward compatibility with older versions of the **seca 115**. For a summary of technical modifications, see the section entitled “Technical modifications” on page 74.

1.3 User qualification

Administration/network connection The device may only be set up and connected to a network by experienced administrators or hospital technicians.

Measuring mode The device and the **seca 115** PC software may only be operated by persons with sufficient specialist expertise.

1.4 Contraindications

Bioimpedance measurements may **not** be performed on persons exhibiting the following characteristics:

- electronic implants, e.g. cardiac pacemakers
- active prostheses

Bioimpedance measurements may **not** be performed on persons who are connected to one of the following devices:

- electronic life-support systems, e.g. artificial heart, artificial lung
- portable electronic medical devices, e.g. ECG devices or infusion pumps

Bioimpedance measurements may only be performed on persons exhibiting the following characteristics after discussion with the attending physician:

- cardiac arrhythmias
- pregnancy

2. SAFETY INFORMATION

2.1 Safety rules in the instructions for use



DANGER!

Identifies an exceptionally hazardous situation. If you fail to take note of this information, serious irreversible or fatal injury will result.



WARNING!

Identifies an exceptionally hazardous situation. If you fail to take note of this information, serious irreversible or fatal injury may result.



CAUTION!

Identifies a hazardous situation. If you fail to take note of this information, minor to moderate injury may result.

NOTICE!

Indicates that the product may have been operated incorrectly. If you fail to take note of this information, the device may be damaged or the measured results may be incorrect.

NOTE:

Contains additional information on how to use this device.

2.2 Basic safety information

Handling the device

- ▶ Please take note of the information in these instructions for use.
- ▶ Keep the instructions for use in a safe place.
- ▶ The instructions for use are a component of the device and must be available at all times.



DANGER!

Risk of explosion

Do not use the device in an environment in which one of the following gases has accumulated:

- ▶ oxygen
- ▶ flammable anesthetics
- ▶ other flammable substances/air mixtures



CAUTION!

Hazard to patient, damage to device

- Additional devices connected to electrical medical devices must provide evidence of compliance with the relevant IEC or ISO standards (e.g. IEC 60950 for data-processing devices). Furthermore, all configurations must comply with the requirements of standards for medical systems (see IEC 60601-1-1 or Section 16 of the 3rd edition of IEC 60601-1 respectively). Anyone connecting additional devices to electrical medical devices is considered a system configurator and is therefore responsible for ensuring that the system complies with the requirements of standards for systems. Your attention is drawn to the fact that local laws take precedence over the above-mentioned requirements of standards. In the event of any queries, please contact your local specialist dealer or Technical Service.
- Please have maintenance, subsequent verification (only **seca 515**), and BIA measuring technology checks performed every two years.
- Technical modifications may not be made to the device.
- The device does not contain any parts for servicing by the user. Please only have maintenance, technical checks and repairs performed by an authorized service partner. You can find the service partner in your area at www.seca.com or by sending an e-mail to service@seca.com.

- Use only original accessories and spare parts from seca, otherwise seca will not grant any warranty.



CAUTION!

Hazard to patient, malfunction

- Keep other medical devices, e.g. high-frequency surgical devices, at a minimum distance of approx. 1 meter to prevent incorrect measurements or faults with wireless transmission.
- Keep HF devices such as cellphones at a minimum distance of approx. 1 meter to prevent incorrect measurement or faults with wireless transmission.
- The actual transmission output of HF equipment may require minimum distances of more than 1 meter. Details can be found at www.seca.com.

Preventing electric shock



WARNING!

Electric shock

- Set up devices which can be operated with a power pack so that the power supply socket is within easy reach and the power supply can be quickly disconnected.
- Ensure that your local power supply matches the information on the power supply unit.
- Never touch the power supply with wet hands.
- Do not use an extension cable and multiple outlets. This also applies to the USB connection on the touchscreen display.
- Make sure that the power cable is not crushed and cannot be damaged by sharp edges.
- Do not operate the device above an altitude of 3000 m.

Preventing injuries and infections



WARNING!

Hazard to patient

- Subject the device to a hygiene treatment after each measurement (see "Hygiene treatment" on page 64).
- Ensure that the patient does not have any contagious diseases.
- Ensure that the patient does not have any open wounds on the palms of their hands or the soles of their feet.
- Ensure that the device is steady and level.
- The device is not designed to be a standing aid. Assist people with limited mobility, e.g. when they are getting up from a wheelchair.
- Ensure that the weighing platform is dry before the patient steps onto it.
- Ensure that the patient has dry feet before stepping onto the weighing platform.
- Ensure that the patient does not step directly onto the edges of the weighing platform.
- Ensure that the patient steps onto the weighing platform slowly and safely.
- Route the network and power cable such that no one can trip over them.

Preventing device damage

NOTICE!

Damage to device

- Make sure that fluids never get inside the device. These can destroy the electronics.
- Switch off the device before you disconnect the power pack from the power supply.
- If the device is not be used for an extended period, disconnect the power pack from the power supply. Only then is the device de-energized.
- Do not drop the device.

- Do not subject the device to shocks or vibrations.
- Do not place the device in direct sunlight and make sure that it is not placed in the direct proximity of a heat source. The excessive temperatures could damage the electronics.
- Perform function checks regularly as described in the relevant section in this document. Do not operate the device if it is damaged or not working properly.
- Avoid rapid temperature changes. If the device is transported where a temperature difference of more than 20 °C occurs, the device must be left to stand for at least two hours before it is switched on, otherwise condensation may form; this can damage the electronics.
- Use only chlorine and alcohol-free disinfectants which are explicitly suitable for acrylic sheet and other sensitive surfaces (active ingredient: quaternary ammonium compounds, for example).
- Do not use aggressive or abrasive cleaning agents.
- Do not use organic solvents (e.g. white spirit or petroleum spirit).

Dealing with measuring results



WARNING!

Hazard to patient

The **seca 515/514** is **not** a diagnostic device. The device assists the attending physician in reaching a diagnosis.

- ▶ To reach a precise diagnosis and to initiate therapies, the attending physician must conduct thorough examinations and take the results of these into consideration, as well as using the **seca 515/514**.
- ▶ The responsibility for diagnoses and the therapies derived from them lies with the attending physician.



CAUTION!

Hazard to patient

To prevent misinterpretations, measured results for medical purposes may only be displayed and used in SI units (weight: kilograms, height: meters). Some devices have the option of displaying measured results in different units. This is purely an additional function.

- ▶ Only use measurements in SI units.
- ▶ The user takes sole responsibility for the use of measured results in non-SI units.

NOTICE!

Loss of data

- Before you save and re-use values measured with the **seca 515/514** (e.g. in the **seca 115** PC software or in a hospital information system), make sure that the measured values are plausible.
- If measured values have been transmitted from the **seca 515/514** device to the **seca 115** PC software or to a hospital information system, make sure before re-using them that the measured values are plausible and assigned to the correct patient.

NOTICE!

Measurements from third-party devices not compatible

Bioimpedance measurements taken with devices from different manufacturers are not compatible. Follow-up measurements performed on a device other than a seca Medical Body Composition Analyzer may lead to inconsistent data and to misinterpretations of the measured results.

- ▶ Ensure that follow-up measurements are also performed on a seca Medical Body Composition Analyzer.

Dealing with packaging



WARNING!

Danger of suffocation

Packaging made of plastic film (bags) presents a danger of suffocation.

- ▶ Store packaging out of the reach of children.
- ▶ If the original packaging is no longer available, only use plastic bags with safety holes to reduce the danger of suffocation.

NOTE:

Store the original packaging for future use (e.g. returning for maintenance).

3. OVERVIEW

3.1 Controls

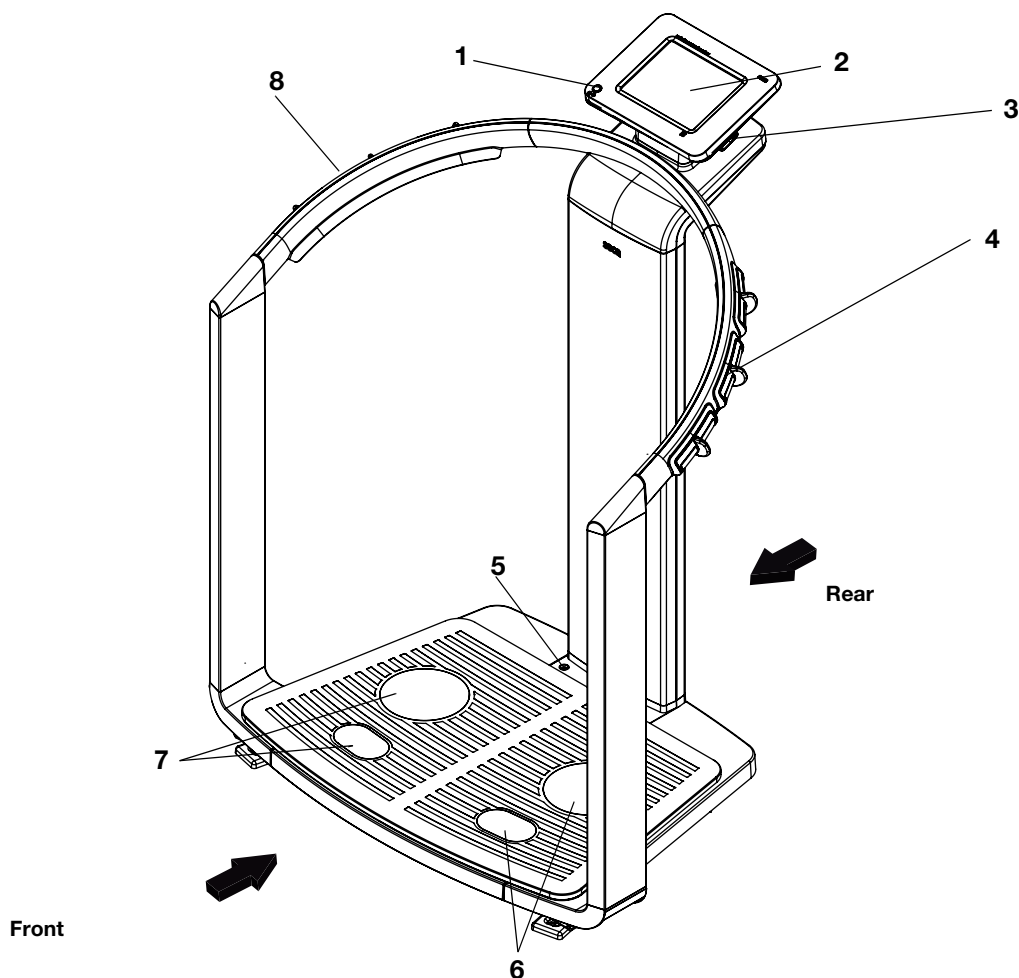

Rear of weighing platform

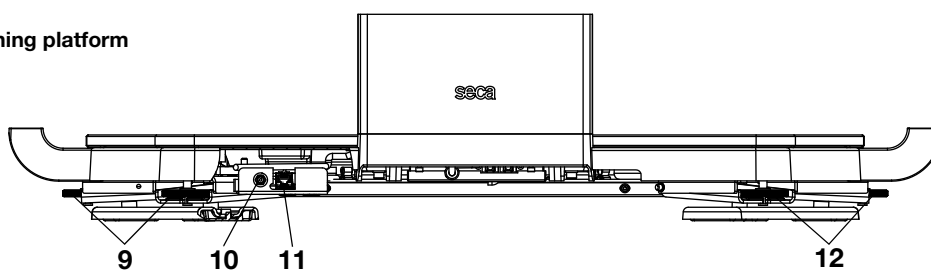









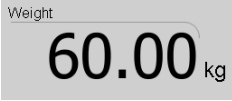

No.	Control	Function
1	ON/OFF button	To switch on the device: press button briefly To switch the device to standby: press button briefly To switch off the device: press button and hold
2	Touchscreen display	Central control and display element, can be swiveled 180° to left and right

No.	Control	Function
3	USB interface	For connecting a USB memory stick (contained in the scope of delivery) for managing the following data: <ul style="list-style-type: none"> • creating seca patient files on the device • loading seca patient files from the seca 115 PC software supplied onto the USB memory stick; calling up data on device • saving measured results on the USB memory stick • reading out log files from the device (administrator function)
4	Pair of hand electrodes, right	3 pcs. with finger spacers, for bioimpedance measurement The patient selects an electrode pair depending on their height
5	Spirit level	Shows whether the device is horizontal
6	Pair of foot electrodes, right	For heels and balls of feet, for bioimpedance measurement
7	Pair of foot electrodes, left	For heels and balls of feet, for bioimpedance measurement
8	Pair of hand electrodes, left	3 pcs. with finger spacers, for bioimpedance measurement The patient selects an electrode pair depending on their height
9	Foot screws, right	2 pcs, for precise alignment of the device
10	Power pack connection	For connecting the power pack
11	Ethernet interface	For integrating the device in a PC network
12	Foot screws, left	2 pcs, for precise alignment of the device





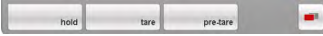
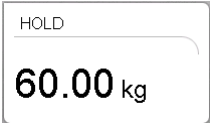

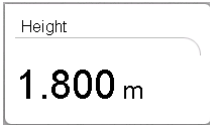
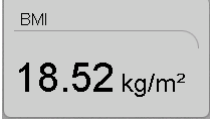









3.2 Symbols in the start display

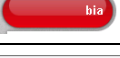

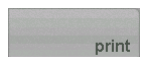

	Symbol	Meaning
A		Header, remains unchanged in all menu levels and tabs. The following data are displayed: <ul style="list-style-type: none"> • patient data <ul style="list-style-type: none"> - name - weight - height - BMI • data connections • date/time
B		Login symbol: shows whether the user is logged in to a seca patient database (user PIN required)
C		Printer symbol: indicates whether the print function of the seca 115 PC software is available.
D		Measuring rod symbol: shows whether there is a connection to a seca 360° length measuring device



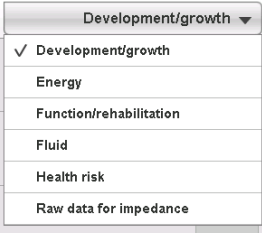

	Symbol	Meaning
E		Data connection symbol: shows the current connection type to the seca patient database (in this case: Ethernet connection to PC using seca 115) Additional possible connection types: <ul style="list-style-type: none">  seca 360° wireless connection to PC using seca 115  USB memory stick connected to device
F		Weight display
G		weight/height tab Automatically active after device switched on For determining weight and height of patient
H		bia tab For performing a bioimpedance analysis
I		patient tab For assigning the measured results to a seca patient file
J		analysis tab For analyzing measured results and analysis results and for saving data
K		switch menu button Appears if secondary menu is available <ul style="list-style-type: none"> Primary menu: contains the functions commonly used in the current context Secondary menu, contains the following functions: <ul style="list-style-type: none"> - settings - print - save
L		Menu bar with context-dependent buttons and switch menu button
M		Hold value display
N		Weighing range currently in use: <ul style="list-style-type: none"> 1: finer increments of the weight display at a lower capacity 2: maximum capacity
O		Non-verifiable function is active (only for verified models)
P		Display of patient's height <ul style="list-style-type: none"> Can be entered manually Can be received by a seca 360° length measuring device
Q		Display of patient's body mass index (BMI) Calculated automatically as soon as a weight is available and a height value has been received or entered





3.3 Color symbols and other controls

Control/display	Symbol	Meaning
ON/OFF button		LED white: device on
		LED green: device on standby
		LED off: device off
Data connection symbol, in this case: seca 360° wireless connection to a PC with seca 115		White: connection available
		Red: data being transmitted via the available connection
		Gray: connection not available
Login symbol: log in to a seca patient database		White: user is logged in
		Gray: no user logged in
Tab		White: tab not selected
		Red: tab selected
Buttons		Light gray: function available
		Gray: button pressed, function selected
		Dark gray: function not available
Electrode indicator (for bioimpedance measurement)		Red: contact poor
		Green: contact good
Drop-down triangles		Gray: function available
		Light gray: function not available
Checkboxes		No tick: function deactivated
		Tick: function activated



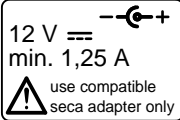



Control/display	Symbol	Meaning
Drop-down menu		Selected function
		Drop-down menu open
Text color		Red text: value outside normal range
		Gray text: value within normal range

3.4 Identification on the device and the type plate

Text/symbol	Meaning
Mod	Model number
Approval type	Type designation of design approval (only seca 515)
S/N	Serial number, consecutive
ProdID	Product identification number, consecutive
	Follow instructions for use
	Medical electrical device, type BF
	Insulated device, protection class II
e	Value in mass units (verified models) Gives the difference between two consecutive display values Used to classify and verify a scale
d	Value in mass units (unverified models) Gives the difference between two consecutive display values
→ ←	Weighing range (verified models)
	Device complies with EC standards and directives. <ul style="list-style-type: none"> • M: Conformity label according to Directive 2014/31/EU governing non-automatic weighing instruments (verified models) • 16: (Example: 2016) Year in which the declaration of conformity was completed and the CE symbol was applied (verified model) • 0102: Notified body metrology (verified models) • 0123: Notified body medical products
	Class III scale to Directive 2014/31/EU and OIML R76-1

Text/symbol	Meaning
 <p>12 V \equiv  min. 1,25 A  use compatible seca adapter only</p>	Operate device only with an original seca power pack
	USB interface
	Do not dispose of device with household waste

3.5 Identification on the packaging

	Protect from wet
	Arrows point to top of product Transport and store upright
	Fragile Do not throw or drop
	Permitted min. and max. temperature for transport and storage
	Permitted min. and max. humidity for transport and storage
	Packaging can be disposed of via recycling programs

4. BEFORE YOU REALLY GET STARTED ...

4.1 Scope of delivery

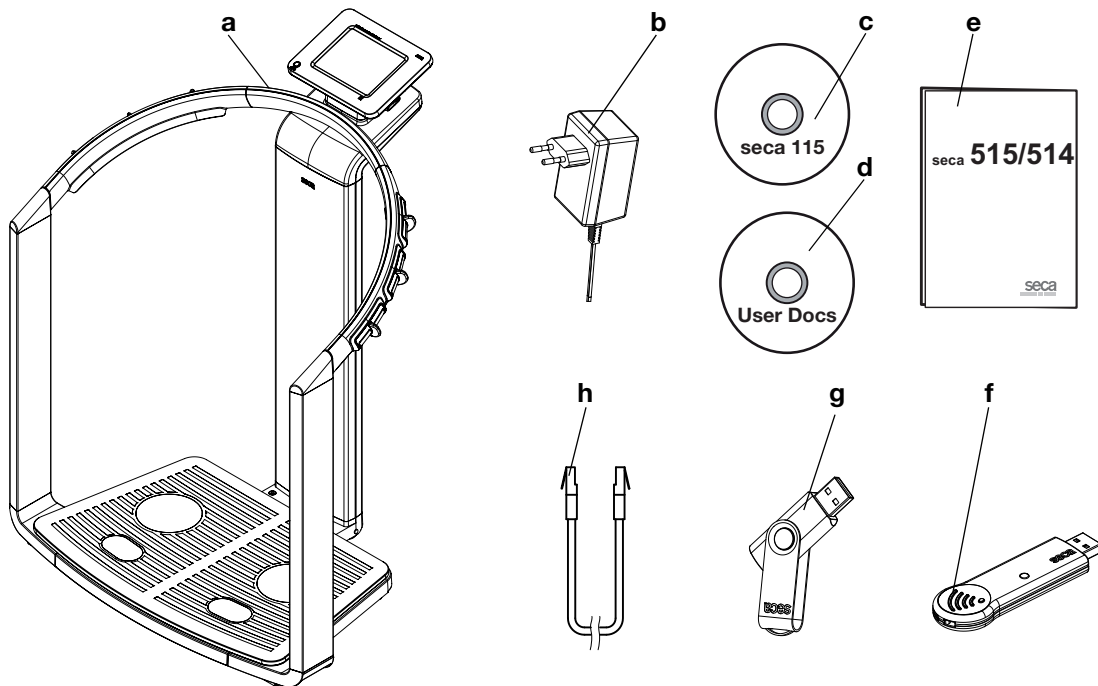

No.	Component	Pcs.
a	Medical Body Composition Analyzer (mBCA)	1
b	Power pack	1
c	DVD with seca 115 PC software and license for one permanent workplace	1
d	"User Documentation" DVD with user documentation in PDF format: <ul style="list-style-type: none"> • instructions for use for doctors and assistants • administrator manual • additional information 	1
e	Instructions for use for doctors and assistants, printed	1
f	seca 360° wireless USB adapter 456	1
g	seca USB memory stick, 2 GB, initialized (USB PIN: 0000)	1
h	Ethernet cable (1.5 m) for connecting to a TCP/IP network	1

4.2 Establishing power supply

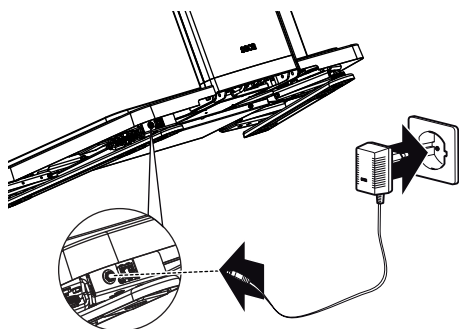

WARNING!
Using the wrong power packs may cause bodily injury or damage to the device

Conventional power packs may deliver a higher voltage than is indicated on them. The device may overheat, catch fire, melt or short-circuit.

- ▶ Use only the original seca power pack as contained in the scope of delivery and listed in the section entitled "Spare parts" on page 74.

The connection for the power pack is located on the underside of the weighing platform. To establish the power supply, proceed as outlined below.

1. Insert the plug required for your power supply into the power pack.
2. Tilt the device forward.
3. Insert the device plug of the power pack into the connector socket of the device.
4. Carefully return the device to an upright position.
5. Plug the power pack into a power supply socket.

4.3 Setting up the device

The device is fully assembled upon delivery.

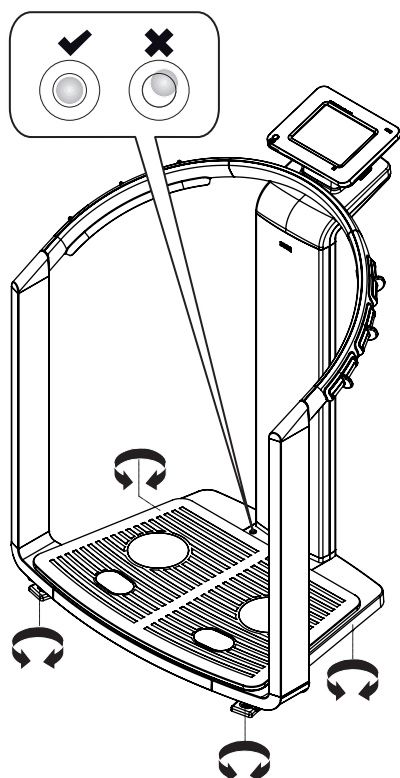

NOTICE!

Incorrect measurement due to force shunt

If the device with its housing is in contact with something, e.g. due to an uneven or soft floor covering, weight will not be measured correctly.

- ▶ Set up the device so that only its foot screws are in contact with the floor.

1. Place the device on a firm, level surface.

NOTICE!

Incorrect alignment may cause incorrect measurements

The spirit level is very sensitive. Additional weights, such as towels, can result in incorrect scale alignment.

- ▶ Align the device only without a load on it.

2. Level the device by turning the foot screws.
 The air bubble in the spirit level must be located in the center of the circle.

4.4 Configuring the device

Sections 4.5 to 4.6 show the data transmission options provided by the device. Your administrator or hospital technician will decide which data connection types to set up for your device. Additional configuration options can be found in the administrator manual on the “User Documentation” DVD supplied. If you have any requests for changes, please contact your administrator or hospital technician.

NOTICE!

Loss of data

Incorrect installation or incorrect changes to the installation can lead to loss of data and, as a result, to misdiagnoses.

- ▶ Make sure the installation or changes to the installation are carried out by an experienced administrator or hospital technician.

4.5 Operating the device in a PC network

The device does not have “on-board” patient and user management. If you wish to manage seca patient files and user accounts, the device must be connected to a PC on which the **seca 115** PC software is installed. You have the following connection options:

- network connection via **seca 360°** wireless network or Ethernet
- indirect connection via USB memory stick

Connecting the network via Ethernet or seca 360° wireless network

If the device is connected via **seca 360°** wireless network or Ethernet to a PC on which the **seca 115** PC software is installed, you can directly access seca patient files of the PC software and transmit newly-created seca patient files directly to the PC software.

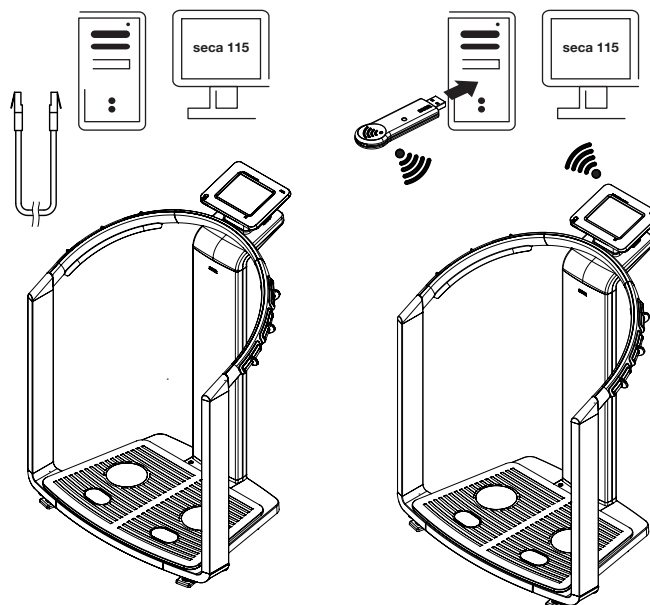

NOTE:

- Information on creating and saving seca patient files can be found in the section entitled “Assigning a measurement to a patient file” from page 36.
- Follow the instructions for use for doctors and assistants for the **seca 115** PC software. If you have any queries regarding data connections, contact your administrator.

Printing

If the device is connected to the **seca 115** PC software via Ethernet, you can use the specific printing function of the PC software and print out detailed results reports on a PC printer.

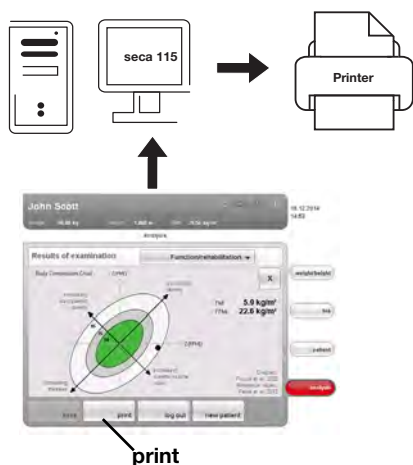

You can start printing a results report directly from the Medical Body Composition Analyzer (see “Printing results report” on page 44). The data are transmitted to the **seca 115** PC software and automatically passed on to the connected PC printer.

NOTE:

- Analysis results are **not** saved automatically if they are transmitted to the **seca 115** PC software for printing. To prevent data loss, follow the information in the section entitled “Saving the measured results” on page 43.
- Follow the instructions for use for doctors and assistants for the **seca 115** PC software. If you have any queries regarding data connections, contact your administrator.

Indirect connection via USB memory stick

If the device is not to be directly integrated in a PC network, you can create seca patient files and save measurements on the seca USB memory stick supplied.

The seca USB memory stick is supplied initialized, meaning it contains a seca patient database and is secured with an initial USB PIN (0000).

If you wish to use additional USB memory sticks (seca original accessories recommended), these must also be initialized before seca patient files can be saved on them. Contact your administrator for this.

You can synchronize the seca patient database on the USB memory stick with the seca patient database of the **seca 115** PC software.

NOTE:

- Information on creating and saving seca patient files can be found in the section entitled “Assigning a measurement to a patient file” from page 36.
- Follow the instructions for use for doctors and assistants for the **seca 115** PC software. If you have any queries regarding data connections, contact your administrator.

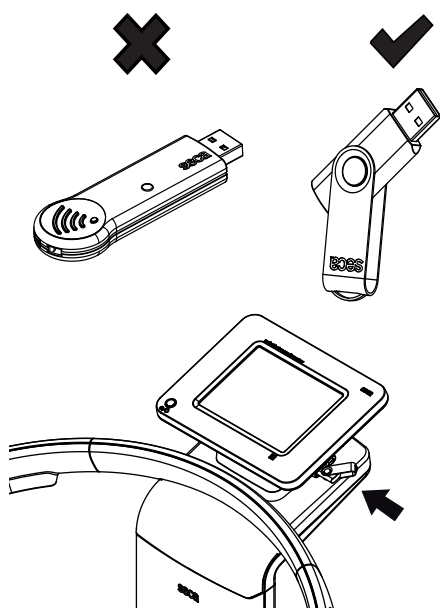

4.6 Operation using a seca 360° length measuring device

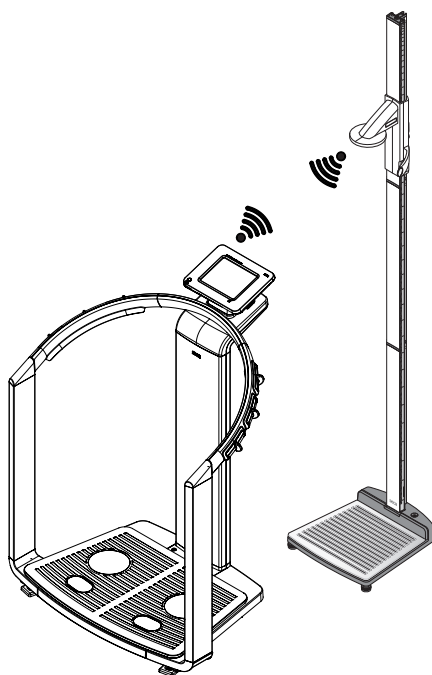

As an alternative to manual entry, you can also use a **seca 360°** length measuring device to determine height and transfer this to the device via **seca 360°** wireless network.

Height is taken into account when analyzing the bioimpedance measurement. If the device is connected to the **seca 115** PC software, height is recorded in a seca patient file together with the other measured results and transmitted to the **seca 115** PC software.

NOTE:

- Information on creating and saving seca patient files can be found in the section entitled “Assigning a measurement to a patient file” from page 36.
- Also follow the instructions for use for the **seca 360°** length measuring device. If you have any queries regarding data connections, contact your administrator.

5. OPERATION

5.1 Operating concept

Swiveling the touchscreen display

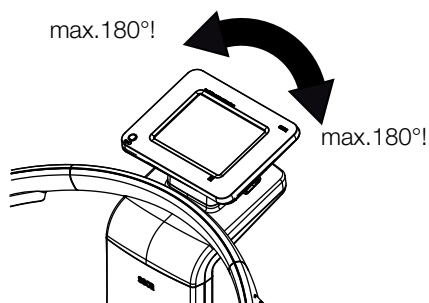

The touchscreen display of the device can be swiveled. As a result, it can be perfectly positioned for every application.

- Swivel the touchscreen display so that is convenient for you to operate and read.

NOTICE!

Damage to device

The swivel mechanism of the touchscreen display has an end stop. Do not attempt to swivel the touchscreen display by more than 180°. This will lead to mechanical damage to the housing and the internal cabling.

- In every direction, only rotate the touchscreen display as far as the end stop.

Switching on the device



The device is switched on using the ON/OFF button. During the switch-on procedure, the device performs a self-test. The self-test may take several seconds.

1. Press the ON/OFF button briefly.

The LED of the button is white.

The internal PC of the device boots up. This takes several seconds.

The weighing function is available when the LED of the button is permanently white and the **weight/height** tab is shown in the display.

2. In the display, press the **bia** tab.

The bioimpedance analysis function is available if the **self-test active** message is no longer displayed and the **module selection** dialog window appears.

The device is ready for operation.

Selecting functions

Functions can be selected using the following elements of the touchscreen display:

- tabs
- buttons
- drop-down menus
- checkboxes

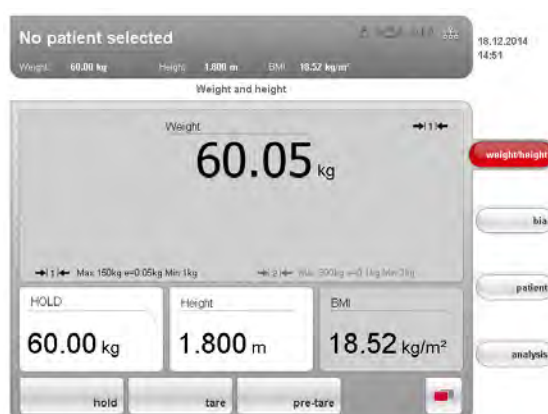

- To select a function, press directly on the corresponding display element (in this case: tabs, buttons).

Selecting extended functions

Functions commonly used in a certain context are accessible in the primary menu. Additional functions are accessible in the secondary menu.

NOTE:

The assignment of functions to the primary and secondary menus is specified at the factory and cannot be changed.



1. Press the **switch menu** button.

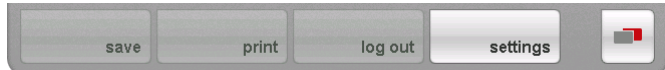

The secondary menu is displayed.

2. Press the **switch menu** button again.

The functions in the primary menu are shown again.

Entering text

Text is entered via a computer keyboard shown on the touchscreen display.

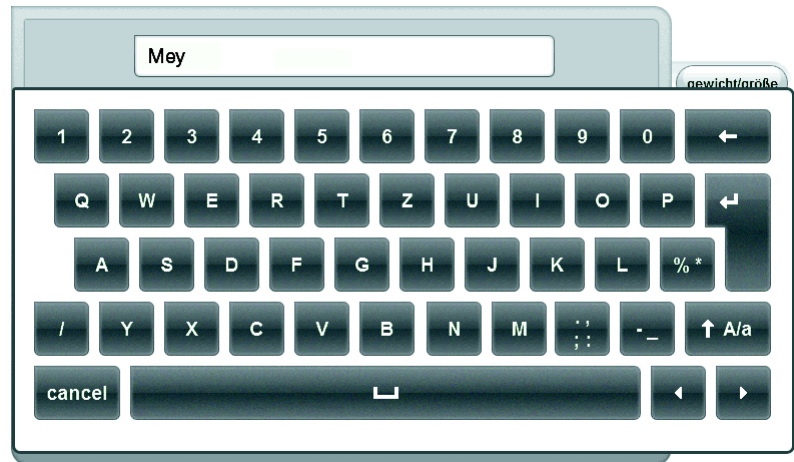

1. Press an input field.
If the field is intended to have text entered in it, a computer keyboard appears in the display.
2. Type in the desired text.
3. Press the Enter key on the keyboard.
The entry is accepted.



Display special characters

Special characters can also be displayed with the computer keyboard.

1. Press and hold down any key on the computer keyboard (in this case “u” key) .



All special characters are displayed in a context menu that is accessible via the selected key (in this case four special characters available).

2. In the context menu, press the desired special character.
The special character appears in the input field.
3. Enter further text as usual.

Entering numbers

Numbers are entered via a computer numerical keypad shown in the touchscreen display.



1. Press an input field.
If the field is intended to have numbers entered in it, a numerical keypad appears in the display.
2. Type in the desired number.
3. Press the Enter key on the numerical keypad.
The entry is accepted.



Measuring procedure

The operating concept is based on the typical measuring procedure outlined below.



- Measure weight and height
- Perform a bioimpedance measurement
- Assign measurements to a seca patient file
- Evaluate measured results
- Save measuring procedure

The order of the tabs on the touchscreen display follows this sequence. It is possible to operate in a different order.

NOTICE!

Loss of data

If there is no new entry for approx. 5 minutes, the current measurement is discarded. In this case, the complete measuring procedure will have to be repeated.

- ▶ Save or print the measured results immediately after conclusion of the measuring procedure (see "Closing the measuring procedure" on page 43).

Automatic standby

The device automatically switches to standby if there are no entries on the device for 5 minutes. This has the following effects:

- measured results and settings which have not been saved are lost.
- the LED of the ON/OFF button is green.
- the touchscreen display goes out.



Switching off the device



WARNING! Electric shock

The device cannot be de-energized by pressing the ON/OFF button.

- ▶ Always take out the power supply plug if the device needs to be de-energized - e. g. for a hygiene treatment.



- ▶ Press the ON/OFF button briefly.
The LED of the ON/OFF button is green. The touchscreen display goes out. The device is on standby.



- ▶ Press and hold the ON/OFF button
The LED of the ON/OFF button goes out. The touchscreen display goes out. The device is switched off.

NOTE:

When switching back on from standby, the device starts immediately in the **weight/height** tab. When the device is switched on having been switched off, the internal PC boots up again. This takes several seconds.

5.2 Determining weight and height

NOTICE!

Incorrect measurement due to force shunt

All the controls of the device are in the so-called weight-sensitive area. If you touch or lean on the device when measuring a patient, this will affect the measured results.

- ▶ During the measuring procedure, ensure that the device is only touched by the patient who is currently being measured.

Starting the weighing procedure



1. Ensure that the device has no load.
2. Switch on the device.
The LED of the ON/OFF button is white
3. Wait until the **weight/height** tab is active.

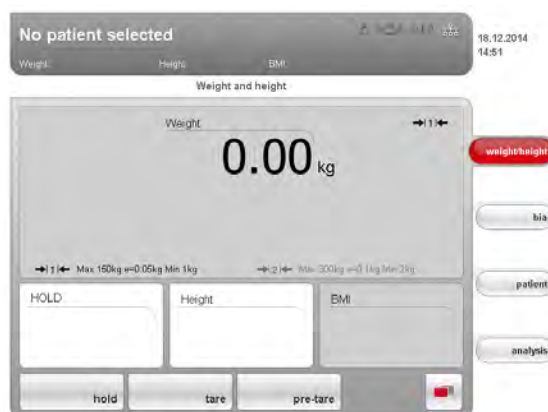

WARNING!

Injury from falling

The device is not designed as a standing aid.

- ▶ Assist persons with limited mobility when they are getting up, e.g. from a wheelchair.

NOTE:

If you wish to perform a bioelectric impedance analysis directly thereafter, ensure that the patient steps on the scale with bare feet (see "Performing a bioimpedance measurement" on page 31).

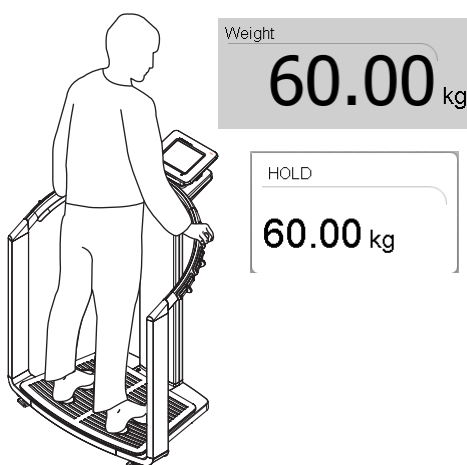

4. Ask the patient to position themselves on the device.
The weight display flashes.
The hold value is determined automatically.
5. Wait until the weight display and the hold value are no longer flashing.
6. Read off the measured result.

NOTICE!

Loss of data

If there is no new entry for approx. 5 minutes, the current measurement is discarded. The complete measuring procedure will have to be repeated.

NOTE:

When the patient steps off the device, the hold value will continue to be displayed. This enables you to attend to the patient before recording the weight. To delete the hold value, press the **hold** button.

Manually determining hold value (hold)

The device is equipped with an autohold function. During the measuring procedure, the weight is automatically frozen and the message "HOLD" is displayed in the window. It is possible that you will have to determine the hold value manually, e.g. if the patient removes an item of clothing after the initial weighing without stepping off the scale. In this case, proceed as outlined below.

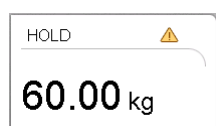
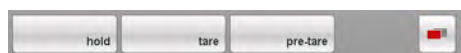

1. Press the **hold** button.
The display flashes until a stable weight is measured. The weight is then continuously displayed. The  symbol is displayed (verified models only).
2. Read off the measured result.

NOTE:

When the patient steps off the device, the hold value will continue to be displayed. This enables you to attend to the patient before recording the weight. To delete the hold value, press the **hold** button.

Taring off additional weight (tare)

Using the **tare** function, you can prevent additional weight (e.g. a towel or a mat on the weighing platform) from influencing the weighing result.

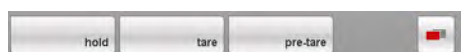

1. Switch on the device.
2. Place the additional weight on the device.
3. Press the **tare** button.
The message "NET" appears on the display.
4. Ask the patient to position themselves on the device.
5. Read off the measured result.
The additional weight is deducted automatically.
6. To deactivate the **tare** function, press the **tare** button again.
The "NET" message is no longer displayed.

NOTE:

The maximum weight which can be displayed is reduced by the weight of the objects already placed on the scale.

Permanently storing additional weight (pre-tare)

Using the **pre-tare** function, you can permanently save an additional weight and automatically subtract this from a measurement result. For example, you can save a standard figure for clothing and then always deduct this if a patient is weighed fully-clothed. The pre-tare value is retained even after the device has been switched off.

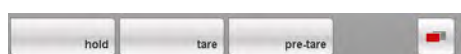

1. Ensure that the device has no load.
2. Switch on the device.
3. Press the **pre-tare** button.
The numerical keypad appears.
The last additional weight saved is displayed.
4. Enter a different pre-tare value if desired.
5. Press the Enter key on the numerical keypad.
The entry is accepted.
The message "PT" appears in the display.
The value entered is saved and automatically subtracted from the measurement result during the next weighing procedure.
The numerical keypad is no longer displayed.

Activating/deactivating pre-tare function

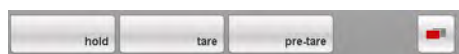

If you wish to have a permanently-saved additional weight automatically subtracted from the measurement result during the current weighing procedure, proceed as outlined below.

1. Switch on the device.
2. Ask the patient to position themselves on the device.
3. Press the **pre-tare** button.
The numerical keypad appears.
The last additional weight saved is displayed.
4. Press the Enter key on the numerical keypad.
The entry is accepted.
The message "PT" appears on the display
The displayed value is automatically subtracted from the measurement result.
The numerical keypad is no longer displayed.
5. Read off the measured result.
6. To deactivate the **pre-tare** function, press the **pre-tare** button again.
The additional weight is added to the measured result once more.

Entering height manually

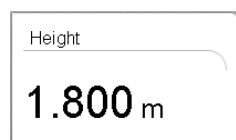

To enter height manually, to determine BMI for example, proceed as outlined below.

1. Ensure that the **weight/height** tab is active.
2. Press the **height** field.
The numerical keypad appears.
3. Enter the patient's height.
4. Press the Enter key on the numerical keypad.
The entry is accepted.

Transmitting height via seca 360° wireless network

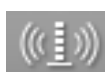

If the device is connected to a **seca 360°** length measuring device, you can transmit height, for determining BMI for example, to the **seca 515/514** via the **seca 360°** wireless network. To do so, proceed as outlined below.

1. Ensure that there is a **seca 360°** wireless connection.
The wireless symbol for the length measuring device is shown in white.

NOTE:

If you are uncertain of whether there is a **seca 360°** wireless connection, contact your administrator or hospital technician.

2. Switch on the length measuring device.
3. Perform the height measurement.
4. Ensure that the **weight/height** tab is active in the touchscreen display of the **seca 515/514**.
5. Press the **send/print** button on the length measuring device.
The measured value appears in the height field.

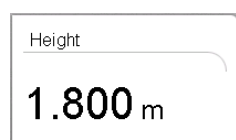

Calculating BMI automatically

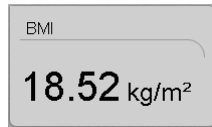

To determine BMI, you have to record the patient's height as well as their weight.

- ▶ After weighing, enter the patient's height.
 - Manually (see “Entering height manually” on page 29)
 - Via the **seca 360°** wireless network (see “Transmitting height via seca 360° wireless network” on page 29)

The BMI is calculated and displayed automatically.

Switching weighing range automatically

The scale has 2 weighing ranges. In weighing range 1, there is a low maximum capacity and the increments of the weight display are more precise. In weighing range 2, you can use the maximum capacity of the scale.

After the scale is switched on, weighing range 1 is active. If a particular weight is exceeded, the scale automatically switches to weighing range 2.

To switch back to weighing range 1, proceed as outlined below.

- ▶ Completely remove the load from the scale.
Weighing range 1 is active again.

Printing partial results

You can print out the measured results so far. Proceed as described in the section entitled “Printing results report” on page 44.

5.3 Performing a bioimpedance measurement

Switching on the device



1. Ensure that the device has no load.
2. Press the ON/OFF button.
The start screen appears.
The **weight/height** tab is active.

Determining weight and height

- Determine weight and height as described in the section entitled “Determining weight and height” from page 27.

Checking module selection



1. Activate the **bia** tab.
Bioimpedance analysis is available when the message “Self-test running” is no longer displayed.
If the device is configured accordingly (see “Configuring the device” on page 61), the **module selection** dialog window appears. The **Raw data for impedance** evaluation module is deactivated at the factory.

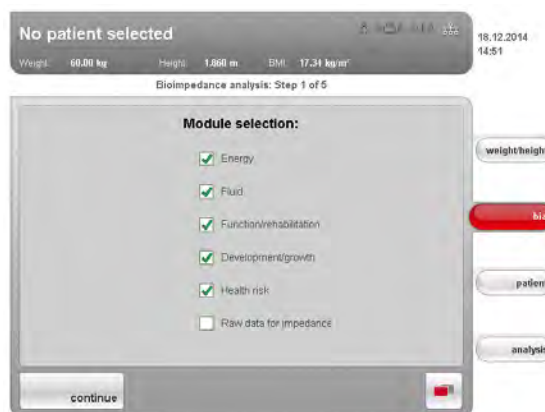

Activation/deactivation of the **Raw data for impedance**, **Energy** and **Health risk** evaluation modules affects bioimpedance analysis as outlined in the table below.

Evaluation module	Setting • = activated, - = deactivated	Effect ^a
Energy	•	Physical activity level (PAL) is interrogated
	-	No interrogation of physical activity level (PAL)
Health risk	•	Waist circumference (WC) is interrogated
	-	No interrogation of waist circumference (WC)
Raw data for impedance	-	Measurement duration: 20 seconds
	•	Measurement duration: 75 seconds Raw data for impedance available for 19 frequencies

a. Interrogation of PAL and WC in the **Module-specific entries** dialog window. Dialog window is skipped if the **Energy** and **Health risk** evaluation modules are deactivated.

2. Check the module selection.

3. Deactivate the modules for which you do not require evaluation.
4. Press the **continue** button.

Starting measurement

1. State whether the patient belongs to a group of people for whom a bioimpedance measurement may not be performed.



- **Yes:** the measurement is not performed. The **weight/height** tab is active again.
- **No:** the procedure continues. The dialog window for positioning the patient appears.

WARNING! **Hazard to patient**

Diseases can be transmitted by poor hygiene.

- ▶ Ensure that the patient does not have any contagious diseases.
- ▶ Ensure that the patient's hands and feet are clean.
- ▶ Ensure that the patient does not have any open wounds on the palms of their hands or the soles of their feet.
- ▶ Disinfect the electrode surfaces after every measurement.

WARNING! **Injury from falling**

The device is not designed as a standing aid.

- ▶ Assist persons with limited mobility when they are getting up, e.g. from a wheelchair.

2. Ask the patient to position themselves on the device.

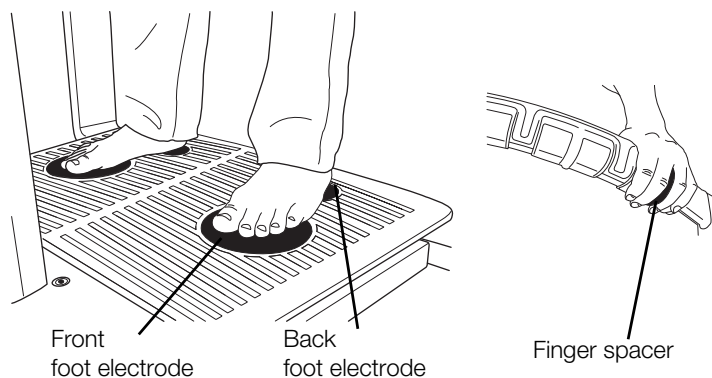

3. Ensure that the patient is standing on the device correctly.

Test point	Characteristics
Hands	<ul style="list-style-type: none"> • Hands must be clean • Same pair of hand electrodes on left and right • Select the pair of hand electrodes such that arms are extended but not under strain • Finger spacers of the hand electrodes between the middle finger and ring finger on both sides
Feet	<ul style="list-style-type: none"> • Stand on device with bare feet • Feet must be clean • Heels on the rear foot electrodes • Balls of feet on the front foot electrodes
Position	<ul style="list-style-type: none"> • Upright position • Knees slightly bent • Do not move during the measurement

4. Ensure that the patient is in good contact with the hand and foot electrodes.

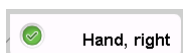
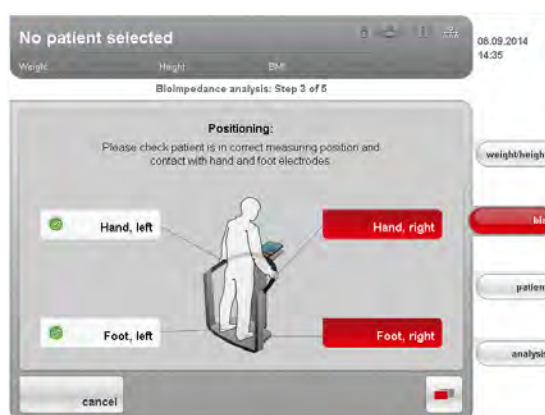

If the patient is not in correct contact with an electrode pair, the corresponding electrode indicator on the touchscreen display will be red.

If the patient is in correct contact with an electrode pair, the corresponding electrode indicator on the touchscreen display will be green.

NOTE

- The selection of hand electrode influences the measurement result. Note the pairs of hand electrodes selected by the patient. In this way, you can ensure that the patient can use the same pairs of hand electrodes for future measurements.
- The electric current passed through the body during the measurement is very low and does not present any health risk. However, in isolated cases, very sensitive persons may feel a slight tingling sensation.

As soon as all the electrode indicators on the touchscreen display are green, a countdown to the start of measurement appears. Measurement starts automatically.



Remaining measurement time is displayed.

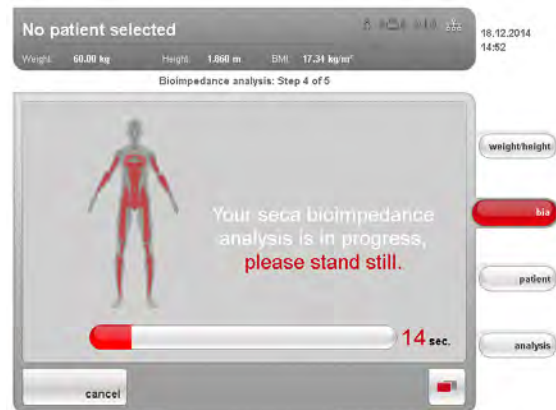

As soon as the measurement ends, the message **End of measurement** appears.

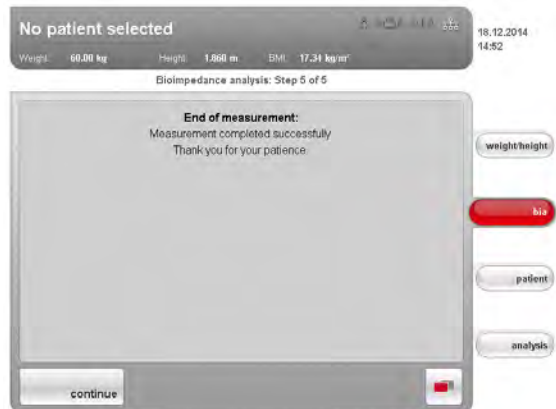

5. Press the **continue** button.

Entering PAL value and waist circumference

The **Module-specific entries** dialog window appears once the bioimpedance measurement is complete. This is where you enter PAL value (PAL = physical activity level) and the patient's waist circumference. The PAL value is required to determine total energy expenditure (**Energy** evaluation module). Waist circumference is required to determine the proportion of visceral adipose tissue (**Health risk** evaluation module).

NOTE:

If one of the module-specific entries has not been interrogated or the **Module-specific entries** dialog window does not appear at all, the associated evaluation modules have been deactivated (see "Starting measurement" on page 32 or "Adapting default module selection for bioimpedance analysis" on page 61).

1. Press the **information** button next to the PAL input field.

A list with typical PAL values and brief descriptions appears.

2. Press the suitable PAL value for your patient.
The list is closed.
The value appears in the input field.
3. Press the input field for waist circumference.
The numerical keypad appears.
4. Enter waist circumference on the numerical keypad.
5. Press the Enter key on the numerical keypad.
The value appears in the input field.
6. Press the **confirm** button.
 - If you have not yet measured weight and height, the **weight/height** tab is active.
 - If you have not yet assigned a seca patient file, the **patient** tab is active.
 - If all data are available, the **analysis** tab is active.

NOTICE!

Loss of data

If there is no new entry for approx. 5 minutes, the current measurement is discarded. The complete measuring procedure will have to be repeated.

Printing partial results

You can print out the measured results so far. Proceed as described in the section entitled "Printing results report" on page 44.

5.4 Assigning a measurement to a patient file

Checking data connection



► Ensure that you can access a seca patient database in one of the following ways:

- the PC with the **seca 115** PC software is switched on and connected to the device via the **seca 360°** wireless network or Ethernet. The corresponding data connection symbol is white.
- the USB memory stick with the seca patient database is connected to the USB interface of the touchscreen display. The corresponding data connection symbol is white.

NOTE:

- If you have connected a USB memory stick containing a seca patient database to the device, you will not be able to access the **seca 360°** patient database of the **seca 115** PC software via Ethernet or seca wireless network.
- If you are uncertain as to how a seca patient database can be accessed, contact your administrator or hospital technician.

Logging on to a seca patient database

If you wish to search for or create seca patient files for the first time after switching on the device, the device will require you to authenticate yourself using your user PIN. For this purpose, proceed as outlined below.



1. Enter your user PIN using the numerical keypad.

NOTE:

If you do not have your user PIN to hand, or if you have questions regarding access rights, contact your administrator or hospital technician.

2. Press the Enter key on the numerical keypad.

The entry is accepted.

The device now accesses the seca patient database.

The login symbol is white. You are logged in to the seca patient database.



NOTICE!**Data access by unauthorized persons**

If you are logged in to a patient database, unauthorized persons can also access seca patient files as long as the device is switched on.

- ▶ Do not leave the device unsupervised if you are logged in to a patient database.
- ▶ Log off the patient database if you need to leave the device unsupervised (see “Logging off from a seca patient database” on page 44).
- ▶ Switch off the device if you are not using it for an extended period.

Searching for a seca patient file

To search for seca patient files, proceed as outlined below.

1. Press the **patient** tab.

The input screen for the patient search appears.

2. Enter at least the one of the following items of data:
 - patient ID
 - date of birth
 - name

NOTE:

It is possible to perform a wildcard search for patient names (e.g. Br* for Brown).

3. Press the **Search** button.

NOTE:

If you are not logged in to a seca patient database, a dialog window appears for user PIN entry. Enter your user PIN as described in the section entitled “Logging on to a seca patient database” on page 36.

The device accesses the seca patient database (in this case: in the **seca 115** PC software via Ethernet). The search may take a few seconds.



All patients who meet the search criterion are displayed.

4. Press the desired entry.



The patient details are displayed.

5. Ensure that you have selected the correct patient.

NOTE:

- If you wish to perform a new patient search, press the **new patient** button.
- If you wish to return to the results list, press the **cancel** button. If the results list has only one entry, the search screen appears.

6. Press the **confirm** button.



The current measurement is assigned to the selected seca patient file. The name of the patient appears in the header of the touchscreen display.

NOTICE!**Loss of data**

The measurement has now been assigned to a seca patient file, but has not yet been saved. If there is no new entry for approx. 5 minutes, the device switches to standby. The seca patient file is no longer available on the device. The current measurement is discarded. The complete process will have to be repeated.

- ▶ Save the measurement as described in the section entitled "Closing the measuring procedure" from page 43.

Providing a seca patient file from the PC software

As an alternative to searching directly on the device, you can also send a seca patient file to the device from the **seca 115** PC software.

NOTE:

This function is only available if you have an Ethernet network connection available.

1. Perform the measurements as described in sections "Determining weight and height" from page 27 and "Performing a bioimpedance measurement" from page 31.
2. Press the **patient** tab on the device.
3. Start the **seca 115** PC software.
4. Perform the following steps in the **seca 115** PC software:
 - select seca patient file
 - click on **send to mBCA**
 - select the seca mBCA to which the seca patient file is to be sent
 - click **send patient file**

The seca patient file is transmitted to the seca mBCA by the PC software and appears in the **patient** tab.



5. Ensure that the correct seca patient file is displayed.
6. Press the **confirm** button on the device.
The name of the patient appears in the header of the touchscreen display. The measurement is assigned to the seca patient file.

NOTICE!**Loss of data**

The measurement has now been assigned to a seca patient file, but has not yet been saved. If there is no new entry for approx. 5 minutes, the device switches to standby. The seca patient file is no longer available on the device. The current measurement is discarded. The complete process will have to be repeated.

- ▶ Save the measurement as described in the section entitled "Closing the measuring procedure" from page 43.

Creating a new seca patient file

1. Press the **patient** tab.

The input screen for the patient search appears.

2. Press the **Create** button.

NOTE:

If you are not logged in to a seca patient database, the dialog window for entering your user PIN appears. Enter your user PIN as described in the section entitled “Logging on to a seca patient database” on page 36.

The device accesses the seca patient database (in this case: in the **seca 115** PC software via Ethernet).

The initial input screen for patient data (mandatory fields) appears.

3. Enter the following patient data:
 - date of birth
 - gender
 - ethnicity

NOTE:

You can find information regarding the influence of ethnicity on the evaluation of a bioimpedance analysis in the section entitled “Medical basis” from page 45.

4. Press the **continue** button.

No patient selected

Weight: 60.00 kg Height: 1.860 m BMI: 17.34 kg/m²

18.12.2014 14:52

Create patient: Step 2 of 2

Name: Scott

First name: John

ID:

confirm cancel back

weight/height
bia
patient
analysis

The second input screen for patient data (optional fields) appears.

5. Enter the following patient data:
 - First name
 - Surname
 - Patient ID

NOTE:

You only need to enter a patient ID if this has to follow a specific structure in your institution. If you do not enter an ID, then an ID will be assigned automatically when the data are saved.

6. Press the **confirm** button.

No patient selected

Weight: 98.80 kg Height: 1.860 m BMI: 28.56 kg/m²

18.12.2014 14:52

Patient file

John Scott
(seca_2012062044258-971)

Date of birth	01.04.1978
Gender	Male
Ethnicity	Caucasian
Weight	98.80
Height	1.860 m
BMI	28.56 kg/m ²

new patient cancel confirm

weight/height
bia
patient
analysis

A summary of the patient data is shown.

7. Press the **confirm** button again.
The patient data are saved.

Editing patient data

You cannot make changes to patient data directly on the device. If you discover that patient data need to be changed, make the changes using the **seca 115** PC software. For further information, see the user documentation for the **seca 115** PC software.

5.5 Viewing analyses

NOTE:

This section describes navigation in the **analysis** tab. For information about the medical content of the evaluation modules, see the section entitled "Medical basis" from page 45.

1. Press the **analysis** tab.
The **Examination results** dialog window appears.
The results for the first evaluation module (in this case: **Function/rehabilitation**) are displayed.



2. For graphical analysis of individual results, press the drop-down triangle ▼ in the corresponding line.
The graphical analysis appears:

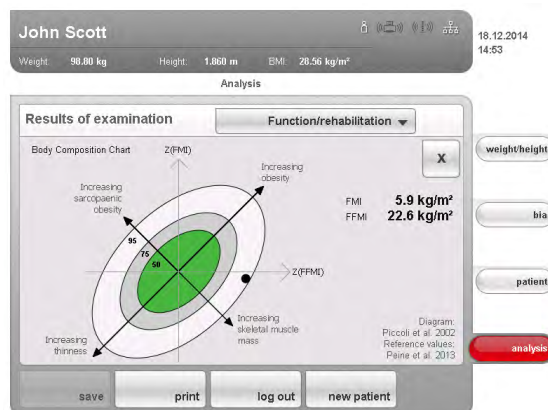

3. To close the graphical analysis, press the **X** button.
4. To see the results of the other modules selected, press the drop-down menu.

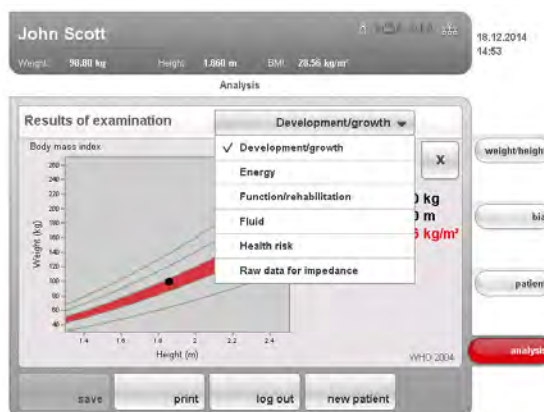

The drop-down menu opens.

5. Press the evaluation module you wish to view.

5.6 Closing the measuring procedure

Saving the measured results



1. Ensure that you can access a seca patient database in one of the following ways:
 - the PC with the **seca 115** PC software is switched on and connected to the device via the **seca 360°** wireless network or Ethernet. The corresponding data connection symbol is white.
 - the USB memory stick with the seca patient database is connected to the USB interface of the touchscreen display. The corresponding data connection symbol is white.

NOTE:

- If you have connected a USB memory stick to the device, you will not be able access the data of the **seca 115** PC software via Ethernet or the **seca 360°** wireless network.
- If you are uncertain as to how a seca patient database can be accessed, contact your administrator or hospital technician.



2. Press the **switch menu** button.



The secondary menu appears.

3. Press the **save** button.
 - If you are logged in to a seca patient database, the measured results will be saved. The corresponding data connection symbol is red.
 - If you are not logged in to a seca patient database, the dialog window for user PIN entry appears. Enter your user PIN as described in the section entitled “Logging on to a seca patient database” on page 36. The measured results are saved. The corresponding data connection symbol is red.
4. Log off from the seca patient database as described in the section entitled “Logging off from a seca patient database” on page 44. The measuring procedure is complete.

Printing results report

If the device is connected to a PC printer via **seca 115**, you can start printing out a results report directly on the device.

If the measurement is not assigned to any seca patient file, an anonymous results report is compiled.

1. Ensure that there is a network connection (**seca 360°** wireless connection or Ethernet).

The corresponding symbol on the touchscreen display is white.



NOTE:

If you are uncertain of whether there is a network connection, contact your administrator or hospital technician.

2. Ensure that the PC and PC printer are switched on.

The printer symbol on the touchscreen display is white.



3. Press the **switch menu** button.



The secondary menu appears.

4. Press the **print** button.

The results report is compiled and printed.

The printer symbol is red.



Logging off from a seca patient database

To log off from a seca patient database, proceed as outlined below.

NOTICE!

Loss of data

If you log off without saving the measuring procedure, all data in the current measuring procedure will be lost.

- Save the current measurement before logging off from a seca patient database (see “Saving the measured results” on page 43).

1. Press the **switch menu** button.

The secondary menu appears.



2. Press the **log off** button.

The login symbol is grayed out. You have been logged off from the seca patient database.



6. MEDICAL BASIS

This section briefly describes the principles of bioimpedance analysis, as well as the content and medical objectives of the evaluation modules pre-set in this device.

For additional information, we refer you to the appropriate professional literature.

6.1 Bioimpedance analysis (BIA)

Classic body composition analysis

The current “gold standard” for body composition analysis comprises a combination of methods, some of which are highly technical and very time-consuming, for determining individual parameters. The parameters are considered in combination with the weight and height of the patient. This allows the nutritional condition and health risk of the patient to be assessed on an individual basis. The table below provides an overview of the gold standard parameters and the corresponding determination method.

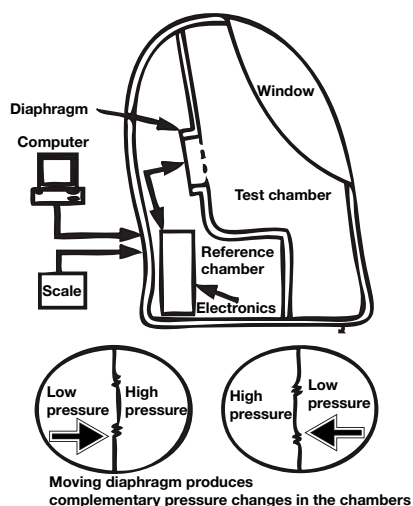

Air displacement plethysmography (ADP)



Dual energy X-ray absorptiometry (DEXA)

Parameter	Method
Total body water (TBW)	Dilution method, tracer: deuterium
Extracellular water (ECW)	Dilution method, tracer: sodium bromide
Fat mass (FM)	Calculation based on the four-component model ^a from the variables: body volume, bone minerals, weight and total body water.
Visceral adipose tissue (VAT)	Magnetic resonance tomography (MRT)
Fat-free mass (FFM)	Difference between weight and fat mass
Skeletal muscle mass (SMM)	Magnetic resonance tomography (MRT)

a. Fuller NJ, Jebb SA, Laskey MA, Coward WA, Elia M. Four-component model for the assessment of body composition in humans: comparison with alternative methods, and evaluation of the density and hydration of fat-free mass. Clin Sci 1992; 82: 687-693.

A high degree of technical complexity is required to determine fat mass. The table below serves as an overview of this also.

Parameter	Method
Total body water (TBW)	Dilution method, tracer: deuterium
Body volume	Densitometry, e.g. air displacement plethysmography (ADP)
Bone minerals	Dual energy X-ray absorptiometry (DEXA)

The high technical and financial outlay, combined with considerable time and space requirements, mean that the “gold standard” is unsuitable for day-to-day operations in clinics and medical practices.

Functional principle of bioimpedance analysis

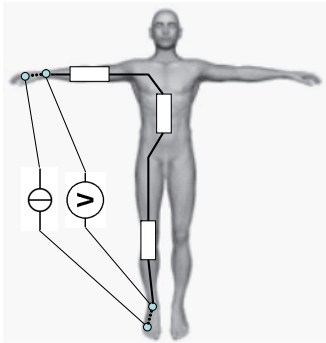

Equivalent circuit diagram:
measurement of total body impedance

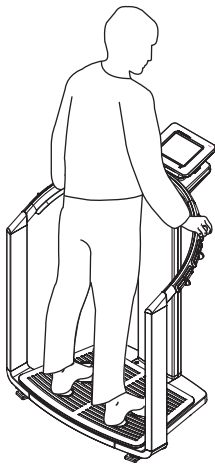

seca 515/514:
measurement of total body impedance

Pioneering achievement: seca formulas

Bioimpedance analysis is a method for rapid, simple and non-invasive assessment of body composition. Only one measuring procedure on a single device is required.

In a bioimpedance analysis, the human body is regarded as an electrical conductor in an alternating current circuit and its alternating current resistance (impedance) is measured.

The following properties of an electrical conductor have an impact on its impedance:

Property	Correspondence in humans
Length	Height
Cross-section	E.g. waist circumference
Material	Body water, cell tissue

When it comes to the human body, age, gender, physical fitness and ethnicity also have an impact on impedance.

In the event that a low alternating current is conducted into the body via electrodes on the arms and legs and the voltage drop is measured via a second electrode pair in each case, the components of body impedance below can be determined.

Impedance component	Cause
Resistance (R), ohmic resistance	Body water is a good electrical conductor
Reactance (X_C), capacitive resistance	Cell tissue acts as a capacitor
Phase angle (ϕ)	Phase shift between the maximum current and maximum voltage as a result of the capacitor effect of the cell tissue

If the alternating current is applied at different frequencies, individual parameters can be specifically determined. In this way, for example, the proportion of extracellular water can be determined directly if low frequencies of between 2 and 5 kHz are used. Alternating current at these frequencies is hardly able to penetrate cell walls. Cell walls and intracellular water therefore have a very minor impact on impedance.

Using the measured parameters in combination with the weight, height, age, and gender of a patient, the body composition of the patient can be determined and then assessed. The pre-requisite in this case are formulas calculated according to scientific criteria.

A number of formulas are already available from a number of sources which can be used to determine body composition on the basis of R, X_C , weight, height, age and gender of a patient. The formulas are based on results of what are referred to as validation studies compared to reference methods of the gold standard, such as air displacement plethysmography (ADP) or dual energy X-ray absorptiometry (DEXA), for example.

However, the comparability and accuracy of these formulas must be regarded with a critical eye, as the validation studies were performed with differing reference methods and, in all respects, heterogeneous reference populations. In addition, the study results cannot necessarily be transferred to other manufacturers' devices for technical reasons.

seca therefore developed its own predictive formulas for determining the following parameters for the arms and legs:

- total body water (TBW)
- extracellular water (ECW)
- fat-free mass (FFM)
- skeletal muscle mass (SMM) for arms, legs, torso and whole body

In-house reference values were determined for the following parameters in order to be able to show normal ranges:

- bioimpedance vector analysis (BIVA)
- mass indices (FMI, FFMI)
- phase angle (ϕ)

In order to determine the formulas and reference values, there was close collaboration with the Institute for Human Nutrition and Food Studies at the University of Kiel and joint representative studies were conducted.

In contrast to all formulas published to date, the seca formulas are population-specific. The formulas developed in Kiel apply solely to Caucasian population groups.

Representative surveys were also conducted in the USA in collaboration with the New York Obesity Nutrition Research Center at St. Luke's Roosevelt Hospital. seca formulas for African-American, South/Central American and Asian population groups were developed on the basis of this study.

The seca formulas are implemented only in seca mBCA devices and seca PC software. As such, seca is a pioneer in the well-founded scientific and medically significant determination of body composition by means of bioimpedance analysis.

6.2 Evaluation parameters

Summary of evaluation parameters

With seca, the parameters required for assessing body composition are called evaluation parameters. The table provides an overview of the evaluation parameters of the **seca 515/514**.

On the device and in the **seca 115** PC software, the evaluation parameters are grouped into evaluation modules. This allows certain aspects of body composition to be assessed specifically (see "Evaluation modules" from page 50).

Evaluation parameter	Display	Evaluation module
Bioimpedance vector analysis (BIVA)	<ul style="list-style-type: none"> • Normal range display of R and X_c in co-ordinate system in relation to height • 50 %, 75 %, 95 % percentiles in the form of tolerance ellipses 	<ul style="list-style-type: none"> • "Fluid" from page 56 • "Health risk" from page 57
Body mass index (BMI)	<ul style="list-style-type: none"> • Absolute in kg/m^2 • For children: shown in percentile curves • For adults: graphic display of WHO reference values 	"Development/growth" from page 50
Extracellular water (ECW)	Absolute in l	"Fluid" from page 56
Fat-free mass (FFM)	Absolute in kg	"Function/rehabilitation" from page 54
Fat mass (FM)	<ul style="list-style-type: none"> • Absolute in kg • Relative in % • For adults: normal range display 	<ul style="list-style-type: none"> • "Energy" from page 53 • "Function/rehabilitation" from page 54

Evaluation parameter	Display	Evaluation module
Total energy expenditure (TEE)	Absolute in MJ/d or kcal/d	“Energy” from page 53
Total body water (TBW)	Absolute in l	“Fluid” from page 56
Weight (W)	<ul style="list-style-type: none"> • Absolute in kg • For children: shown in percentile curves 	“Development/growth” from page 50
Height (H)	<ul style="list-style-type: none"> • Absolute in m • For children: shown in percentile curves 	“Development/growth” from page 50
Hydration (HYD)	Relative in %	“Fluid” from page 56
Energy stored in body (E_{body})	Absolute in MJ or kcal	“Energy” from page 53
Impedance (Z)	Absolute in ohms	“Raw data for impedance” from page 59
BCC: mass indices fat-free mass index (FFMI) fat mass index (FMI)	<ul style="list-style-type: none"> • Absolute in kg/m^2 • Normal range display in co-ordinate system in relation to height • 50 %, 75 %, 95 % percentiles in the form of tolerance ellipses 	<ul style="list-style-type: none"> • “Function/rehabilitation” from page 54 • “Health risk” from page 57
Phase angle (ϕ)	<ul style="list-style-type: none"> • Absolute in degrees • Normal range display according to seca reference values with percentile curves 	<ul style="list-style-type: none"> • “Health risk” from page 57 • “Raw data for impedance” from page 59
Reactance (X_C)	Absolute in ohms	<ul style="list-style-type: none"> • “Fluid” from page 56 • “Health risk” from page 57 • “Raw data for impedance” from page 59
Resistance (R)	Absolute in ohms	<ul style="list-style-type: none"> • “Fluid” from page 56 • “Health risk” from page 57 • “Raw data for impedance” from page 59
Resting energy expenditure (REE)	Absolute in MJ/d or kcal/d	“Energy” from page 53
Skeletal muscle mass (SMM)	Absolute in kg	“Function/rehabilitation” from page 54
Visceral adipose tissue (VAT)	Absolute in l	“Health risk” from page 57

seca specialty: co-ordinate system with tolerance ellipses

In addition to the classic display of evaluation parameters in numerical values, bar graphs and percentile curves, the **seca 515/514** uses co-ordinate systems with so-called tolerance ellipses for the graphical display of body impedance and fat-mass indices.

This form of graphical display, named “bioimpedance vector analysis” (BIVA), was developed by Professor A. Piccoli for the interpretation of body impedance.

The transfer of this principle to the display and interpretation of fat mass indices, on the other hand, is a new development by seca in collaboration with the Institute for Human Nutrition and Food Studies at the University of Kiel.

Bioimpedance vector analysis (BIVA)

Professor A. Piccoli's BIVA is a graphical representation of the electrical resistances of the body. To this end, the impedance of the patient is displayed as a measurement point in a co-ordinate system: capacitive resistance (X_C) on the y axis, ohmic resistance (R) on the x axis. Both variables X_C and R are considered relative to height (length of the electrical conductor).

With vector display, a test subject can be investigated simultaneously with regard to his/her total body water – R – and his/her body cell mass – X_C . Changes to the measurement point (R, X_C) parallel to the x axis indicate changes to fluid volume, whilst changes on the y axis indicate an increase or decrease in body cell mass.

The quadrants in the co-ordinate system are named correspondingly:

- I: X_C high, R high = decreasing proportion of water
- II: X_C low, R high = increasing body cell mass
- III: X_C low, R low = increasing proportion of water
- IV: X_C high, R low = decreasing body cell mass

An additional advantage of BIVA is the comparison of an individual measured value to reference values. The 50 %, 75 % and 95 % percentiles are entered in the co-ordinate system in the form of tolerance ellipses.

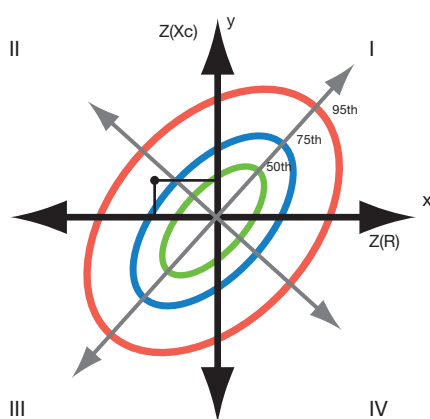

Fat mass indices (FFMI and FMI)

The system developed by Professor A. Piccoli can also be applied to representation of the fat mass indices on the basis of work conducted by Schultz et al., who describe four typical situations for the relationship of FFMI and FMI.

The quadrants in the co-ordinate system are named correspondingly:

- I: FFMI high, FMI high = increasing obesity
- II: FFMI low, FMI high = increasing sarcopenic obesity
- III: FFMI low, FMI low = increasing thinness
- IV: FFMI high, FMI low = increasing skeletal muscle mass

In addition, the FFMI (x axis) and the FMI (y axis) are also plotted for FFMI and FMI on the axes of the co-ordinate system. The 50 %, 75 % and 95 % percentiles are also shown for the fat mass indices in the form of tolerance ellipses.

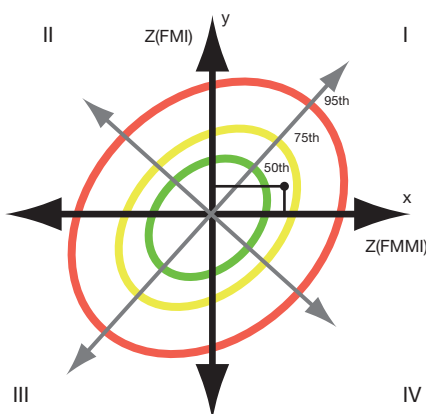

6.3 Evaluation modules

The evaluation modules described below are pre-set in this device and assist you in assessing your patients' state of health.

The evaluation modules offer the option of only viewing those evaluation parameters (see "Evaluation parameters" on page 47) relevant to a specific objective.

For information about how to access the evaluation modules and navigate within them, see "Viewing analyses" from page 42.

Development/growth

This module indicates both the weight and the height of a person and automatically calculates BMI. In this way, weight changes in both children and adults can be monitored.

In children, this module assists with regular checks to assess growth and development.

No bioimpedance analysis is required for this module. The following parameters are displayed:

- weight
- height
- body mass index (BMI)

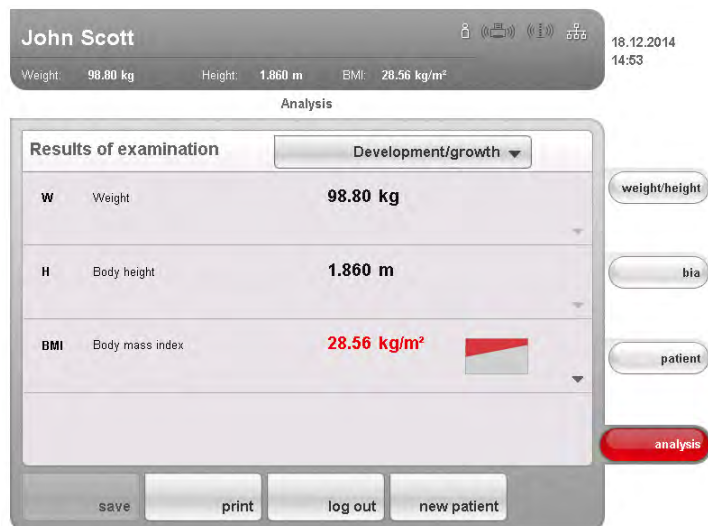

The following detail views are available for this module:

Weight percentile curves for children



Height percentile curves for children

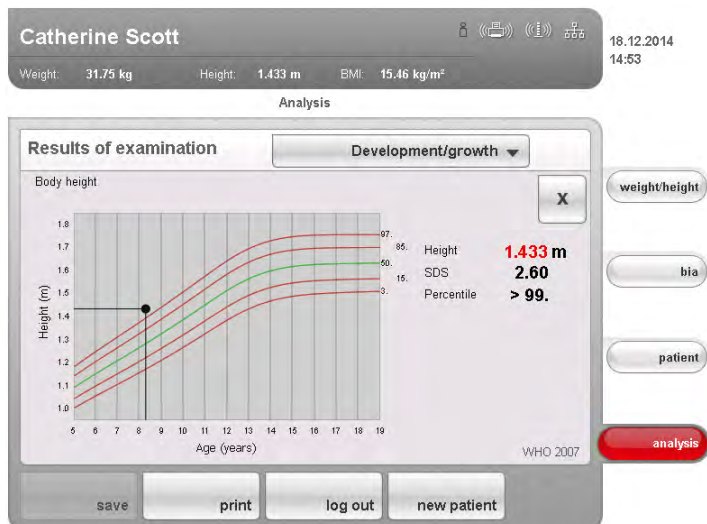

BMI percentile curves for children

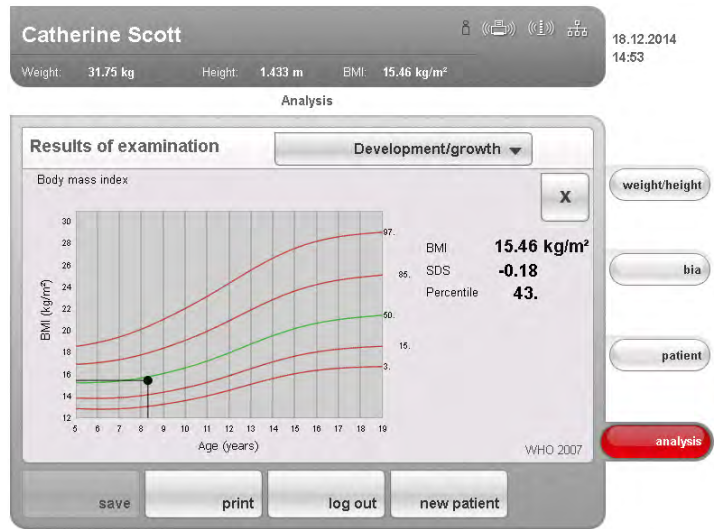

WHO reference values for adults

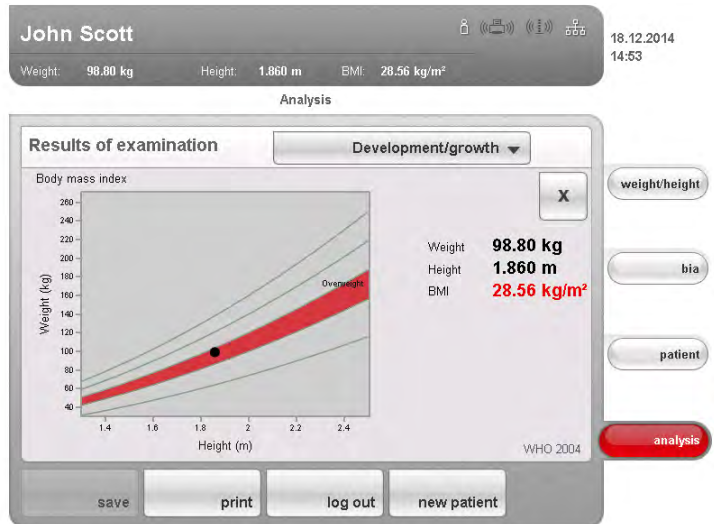

Energy The aim of this module is to determine a person's energy expenditure and energy reserves. The following parameters are displayed:

- fat mass (FM)
- fat mass index (FMI)
- energy stored in the body (E_{body})
- resting energy expenditure (REE)
- total energy expenditure (TEE)

No bioimpedance measurement is required for the resting energy expenditure (REE) parameter. Resting energy expenditure is determined with the aid of the parameters height and weight and with the automatic BMI calculation.

For all other parameters in this module, a bioimpedance measurement is required in addition to height and weight.

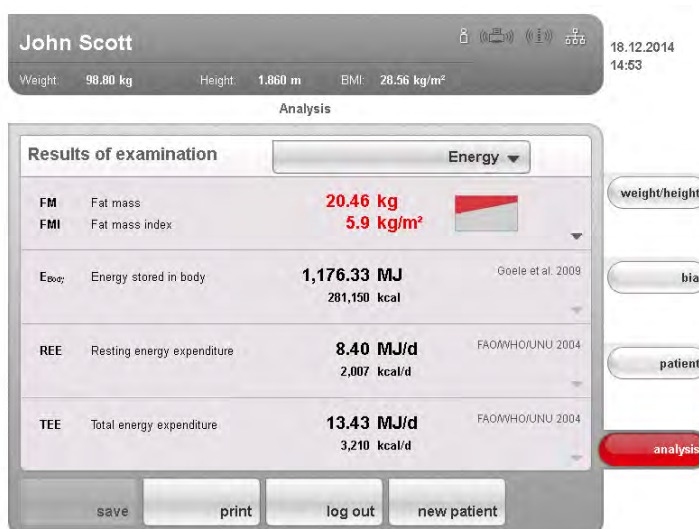

The following detail view is available in this module:

Normal range display of fat mass for adults

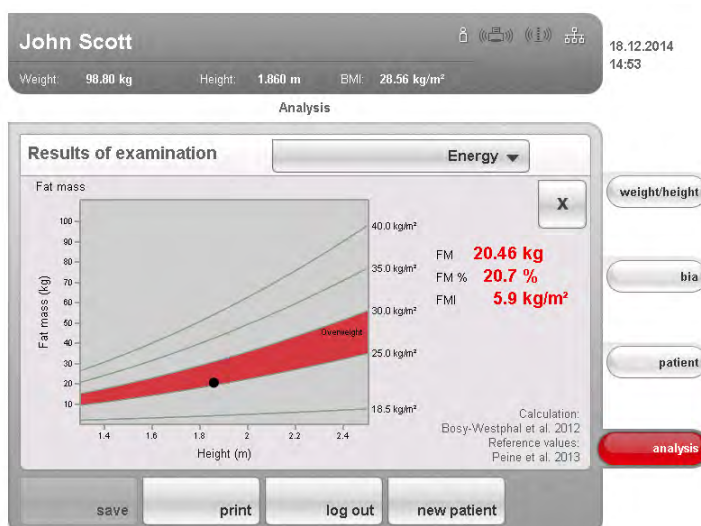

Function/rehabilitation

This module is for determining a person's level of fitness. This allows the success of a training regime to be assessed. For this module, the parameters height and weight are required, as well as a bioimpedance measurement. The following parameters are displayed:

- fat-free mass (FFM)
- fat mass (FM)
- fat mass index (FMI)
- fat-free mass index (FFMI)
- skeletal muscle mass (SMM)

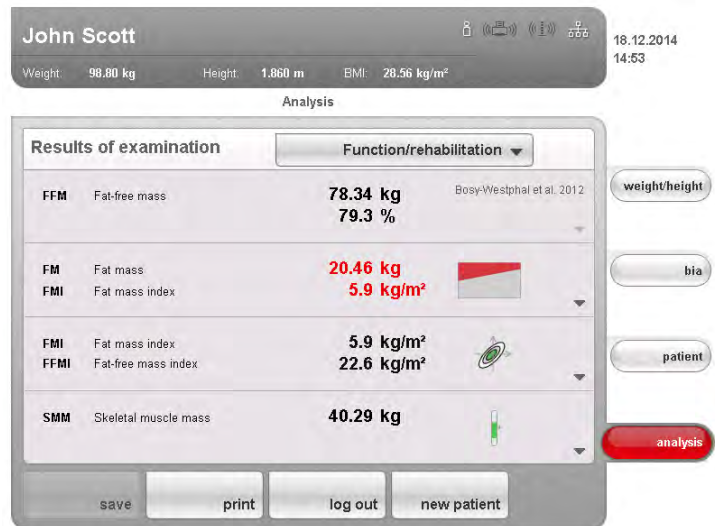

The following detail views are available for this module:

Normal range display of fat mass for adults

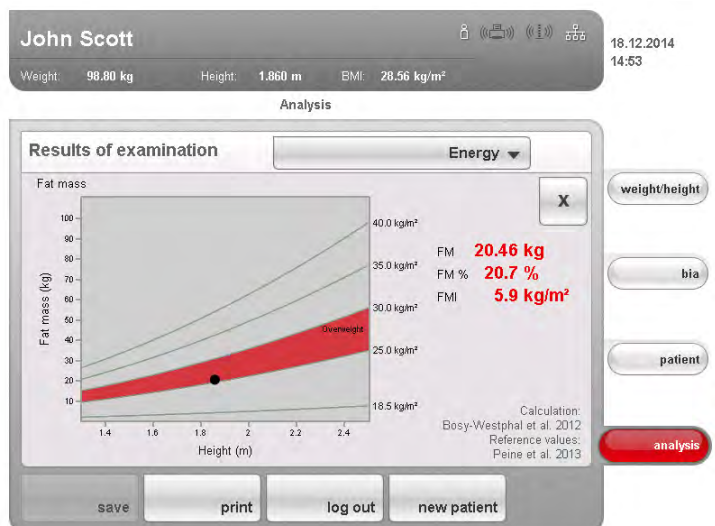

Body Composition Chart (mass indices)

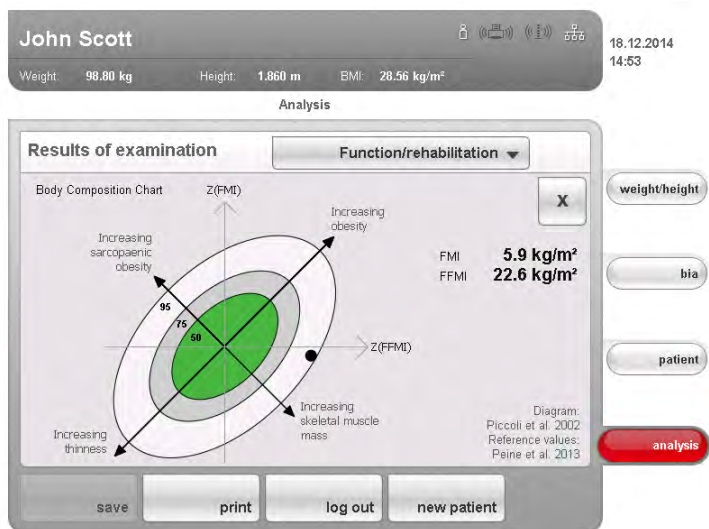

Skeletal muscle mass

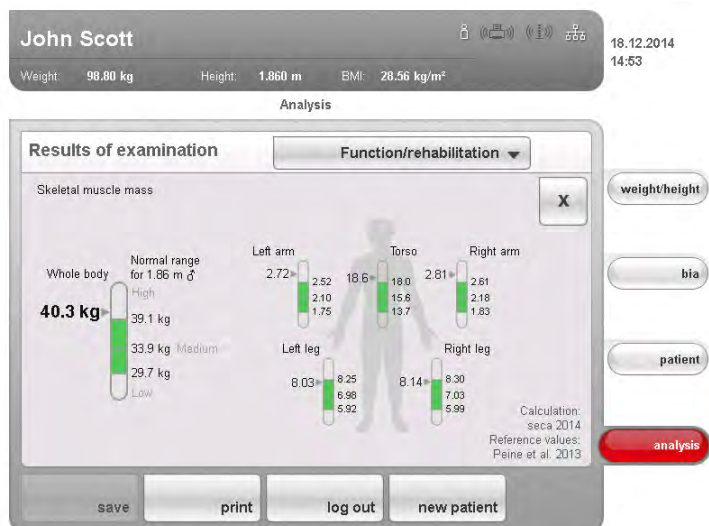

Fluid This module allows a person's fluids status to be determined. For this module, the parameters height and weight are required, as well as a bioimpedance measurement. The following parameters are displayed:

- total body water (TBW)
- extracellular water (ECW)
- hydration (HYD); $HYD = (100 \times ECW) / (TBW - ECW) [\%]$
- bioimpedance vector analysis (BIVA)

John Scott 18.12.2014 14:53

Weight: 98.80 kg Height: 1.860 m BMI: 28.56 kg/m²

Analysis

Results of examination Fluid

TBW	Total body water	58.2 l 58.5 %	Bosy-Westphal et al. 2012
ECW	Extracellular water	23.2 l 23.3 %	Bosy-Westphal et al. 2012
HYD	Hydration	66.2 %	
BIVA	Bioelectric impedance vector analysis	52.9 Ω 455.6 Ω	

save print log out new patient

weight/height
bia
patient
analysis

The following detail view is available for this module:

Bioimpedance vector analysis

John Scott 18.12.2014 14:53

Weight: 98.80 kg Height: 1.860 m BMI: 28.56 kg/m²

Analysis

Results of examination Fluid

Bioelectric impedance vector analysis (BIVA)

Diagram: Piccoli et al. 2002
Reference values: Peine et al. 2013

Increasing body cell mass
Decreasing body cell mass
Increasing proportion of water
Decreasing proportion of water

$Z(X_c/H)$
 $Z(R/H)$

Xc (60 kHz) **52.9 Ω**
R (50 kHz) **455.6 Ω**

save print log out new patient

weight/height
bia
patient
analysis

Health risk The aim of this module is to provide an overview of body composition and to compare the results with values for healthy people. A body composition which deviates from the normal range is an indicator which can be used to assess the risk to health. For this module, the parameters height and weight are required, as well as a bioimpedance measurement. The following parameters are displayed:

- phase angle (ϕ)
- visceral adipose tissue (VAT)
- bioimpedance vector analysis (BIVA)
- fat mass index (FMI)
- fat-free mass index (FFMI)

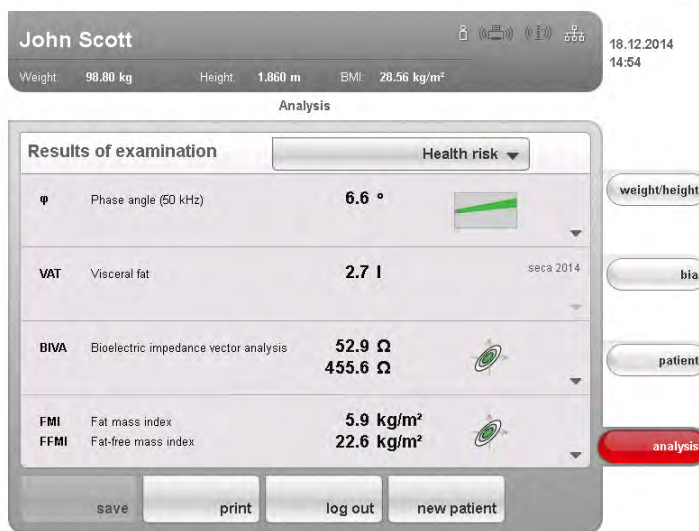

The following detail views are available for this module:

Normal range display for phase angle



Bioimpedance vector analysis

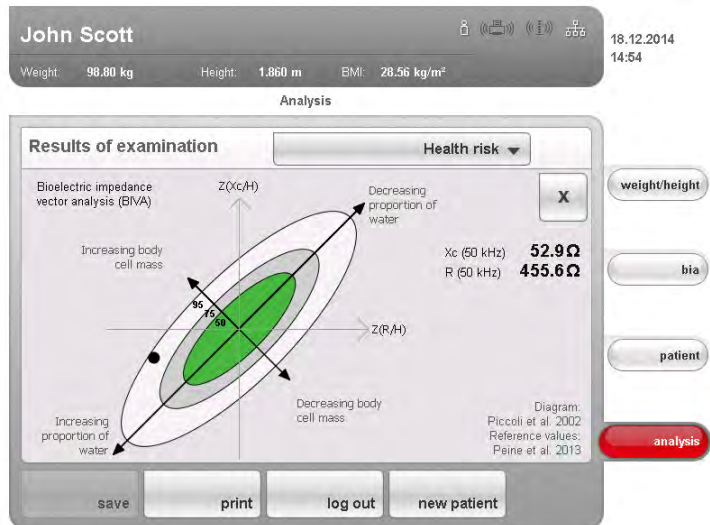

Body Composition Chart (mass indices)

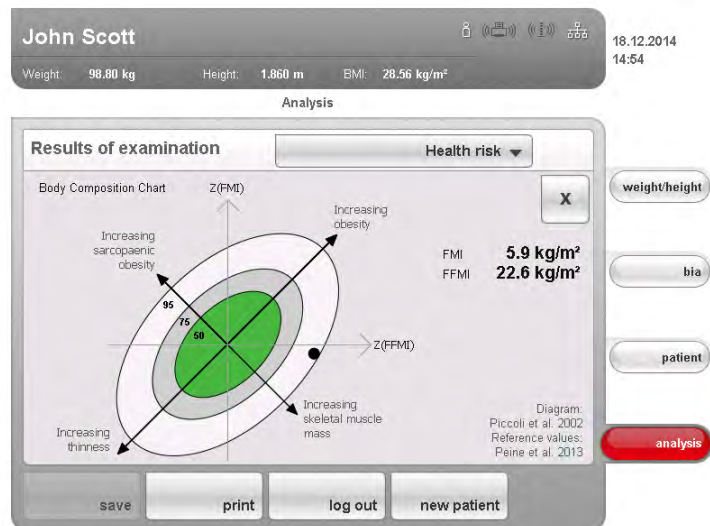

Raw data for impedance

This module shows detailed raw data for resistance (R), reactance (Xc), impedance (Z) and phase angle (ϕ) for information purposes.

You can also view impedance (Z), reactance (Xc), resistance (R) and phase angle (ϕ) for the frequencies 50 Hz and 5 Hz.

John Scott 18.12.2014 14:54

Weight: 98.80 kg Height: 1.860 m BMI: 28.56 kg/m²

Analysis

Results of examination **Raw data for impedance**

Z _i (50 kHz)	456.0 Ω
Z _i (5 kHz)	534.1 Ω
ϕ_{90} (50 kHz)	6.7 °
ϕ_{90} (5 kHz)	3.4 °
R _i (50 kHz)	452.9 Ω
R _i (5 kHz)	533.2 Ω
X _{C_i} (50 kHz)	53.5 Ω
X _{C_i} (5 kHz)	31.3 Ω

weight/height
bia
patient
analysis

save print log out new patient

NOTE:

In the **seca 115** PC software, you can view the raw data for impedance for individual body parts and for additional frequencies. For further information, see the “Instructions for use for doctors and assistants” of the PC software.

6.4 References

The scientific basis for bioimpedance analyses using the Medical Body Composition Analyzer **seca 515/514** is clinical studies. The results of the clinical studies are stored as references in the device software and form the basis for assessing the state of health of your patients.

The references used by the device depend on the country in which you are operating. As part of the device configuration, your administrator will enter your country as the setup location. The usual references for your country will be loaded automatically.

For some evaluation parameters (e.g. waist circumference for children), the reference used also depends on the patient's ethnicity. The device automatically uses ethnicity-dependent references to suit the corresponding entry in the seca patient file (see "Creating a new seca patient file" on page 40).

The evaluation module in question indicates which clinical study is being used as a reference for determining and assessing an evaluation parameter, e. g. "Peine et al. 2013".

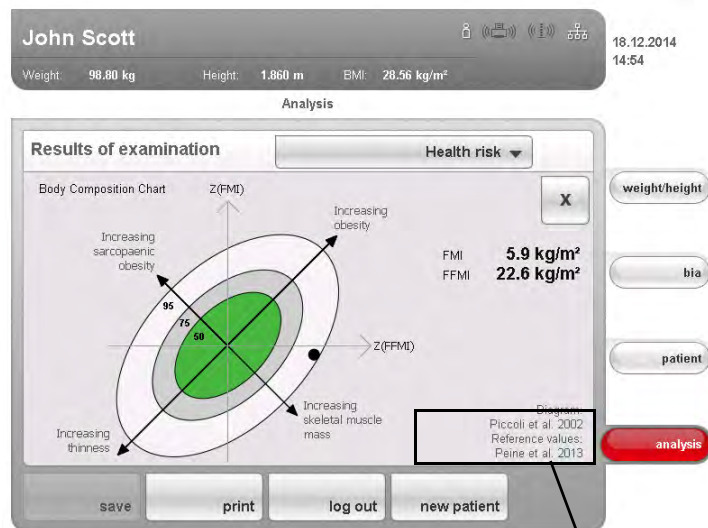

Reference used

Details about the referenced clinical trials can be found on our website www.seca.com.

7. CONFIGURING THE DEVICE

7.1 Adapting default module selection for bioimpedance analysis

The default module selection determines which evaluation modules are considered during a bioimpedance analysis.

The device is factory set, so that when the **bia** tab is activated, the **Default module selection** dialog window appears and all evaluation modules are activated. This way, the module selection can be verified before each measurement and, if necessary, adapted to suit the individual measurement.

The device can be configured in such a way that the **Default module selection** dialog window does not appear if the **bia** tab is activated. You can also create an in-house default module selection.

Showing/hiding default module selection

In order to determine whether or not the **Default module selection** dialog window is displayed before each bioimpedance analysis, proceed as outlined below.



1. Press the **switch menu** button.



The secondary menu is displayed.

2. Press the **settings** button.

The **User** menu appears.



The current setting is displayed (button appears gray = pressed).

3. Press the desired setting.
 - **No**: default module selection is active. It is displayed before every bioimpedance analysis and can be adapted to suit the measurement in question.
 - **Yes**: default module selection is active but is not displayed before the bioimpedance analysis. Adaptations to the default module selection are possible only in the **settings** menu.
4. Press the **apply** button.
The module selection is saved and available from the next bioimpedance analysis.

Creating default module selection

In order to create an in-house default module selection, proceed as outlined below.



1. Press the **switch menu** button.

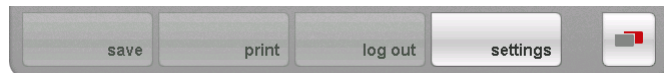

The secondary menu is displayed.

2. Press the **settings** button.
The **User** menu appears.
3. Press the drop-down menu.
The drop-down menu opens.
4. Press the **Default module selection** menu element.



The current module selection is displayed.

The **Raw data for impedance** evaluation module is deactivated at the factory. Activation/deactivation of the **Raw data for impedance**, **Energy** and **Health risk** evaluation modules affects bioimpedance analysis as outlined in the table below.

Evaluation module	Setting • = activated, - = deactivated	Effect ^a
Energy	•	Physical activity level (PAL) is interrogated
	-	No interrogation of physical activity level (PAL)
Health risk	•	Waist circumference (WC) is interrogated
	-	No interrogation of waist circumference (WC)
Raw data for impedance	-	Measurement duration: 20 seconds
	•	Measurement duration: 90 seconds Raw data for impedance available for 19 frequencies

a. Interrogation of PAL and WC in the **Module-specific entries** dialog window. Dialog window is skipped if the **Energy** and **Health risk** evaluation modules are deactivated.

5. Press all modules you wish to deactivate.
The tick in the checkbox is no longer displayed.

NOTE:

Press on a module again to reactivate it.

6. Press the **apply** button.
The module selection is saved and available from the next bioimpedance analysis.

NOTE:

To exit the dialog window without saving, press the **cancel** button or the most recently active tab (red, in this case: **bia**). The most recently active tab is active again.

7.2 Saving settings

Applying settings

1. Press the **apply** button.
The **Save operation successful** dialog window appears.
2. Press the **continue** button.
The **settings\User** menu appears in the display again.
You can implement additional settings in the **settings\User** menu or exit the menu as described in the section entitled "Exiting Settings\user menu" on page 63.

Exiting Settings\user menu

1. Press the **Finish** button.
The **Unsaved changes** dialog window appears.
2. Press the desired button:
 - **Yes**: the changes are saved. The most recently active tab is active again. The device is ready for measurement.
 - **No**: the changes are not saved. The most recently active tab is active again. The device is ready for measurement.

8. HYGIENE TREATMENT



WARNING! **Electric shock**

The device is not de-energized when the on/off button is pressed and the display goes out. Use of fluids on the device may cause electric shock.

- ▶ Before each hygiene treatment, ensure that the device is switched off.
- ▶ Disconnect the power supply before each hygiene treatment.
- ▶ Ensure that no fluids penetrate the device.



CAUTION! **Damage to device**

Unsuitable cleaning agents and disinfectants may damage the sensitive surfaces of the device.

- ▶ Use only chlorine and alcohol-free disinfectants explicitly suitable for acrylic sheet and other sensitive surfaces (active ingredient: quaternary ammonium compounds, for example).
- ▶ Do not use aggressive or abrasive cleaning agents.
- ▶ Do not use organic solvents (e.g. white spirit or petroleum spirit).

8.1 Cleaning

- ▶ Clean the surfaces of the device with a soft cloth as required, dipped in a mild soap solution if necessary.

8.2 Disinfecting

1. Check that your disinfectant is suitable for sensitive surfaces and acrylic sheet.
2. Follow the instructions on the disinfectant.
3. Disinfect the device:
 - Moisten a soft cloth with disinfectant and wipe down the device
 - Comply with the intervals: see table

Interval	Component
Before each measurement	<ul style="list-style-type: none">• weighing platform and foot electrodes• standing aid and pair of hand electrodes
After every measurement	<ul style="list-style-type: none">• weighing platform and foot electrodes• standing aid and pair of hand electrodes
As required	<ul style="list-style-type: none">• touchscreen display• Controls

8.3 Sterilizing

The device may not be sterilized.

9. FUNCTION CHECK

- ▶ Perform a function check prior to each use.

A complete function check includes:

- visual inspection for mechanical damage
- checking the alignment of the device
- visual and function check of the display elements
- function check of all the controls shown in the section entitled “Overview”
- function check of optional accessories

If you notice any faults or deviations during the function check, first try to resolve the error with the aid of the section entitled “What do I do if ...” in this document.



CAUTION! **Personal injury**

If you notice any faults or deviations during the function check which cannot be resolved with the aid of the section entitled “What do I do if ...” in this document, you may not use the device.

- ▶ Have the device repaired by seca service or by an authorized service partner.
- ▶ Follow the section entitled “Servicing” in this document.
- ▶ Follow the section entitled “Servicing/recalibration” in this document.

10. MAINTENANCE/SUBSEQUENT VERIFICATION (VERIFIED MODEL)

10.1 Information on maintenance and subsequent verification

We recommend having your device serviced prior to subsequent verification. The device’s measurement technology for bioimpedance analysis (BIA) must be checked every two years.

NOTICE!

Incorrect measurements as a result of poor servicing

- ▶ Please only have servicing and repairs performed by an authorized service partner.
- ▶ You can find a service partner in your area at www.seca.com or by sending an e-mail to service@seca.com.

Have an authorized technician perform subsequent verification according to national legal regulations.

Subsequent verification is necessary whenever one or more verification seals are damaged or the contents of the verification counter no longer match the number on the applicable verification counter sticker.

10.2 Checking the contents of the verification counter

The scale has been verified. Verifications may only be performed by authorized agencies. To guarantee this, the scale is equipped with a verification counter which records each change in verification-related data.

If you want to check whether the scale has been properly verified, follow the instructions below.

1. Switch on the device.
2. Press the **switch menu** button.



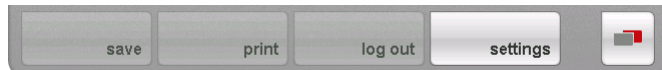

3. Press the **settings** button.
The **User** dialog window appears.

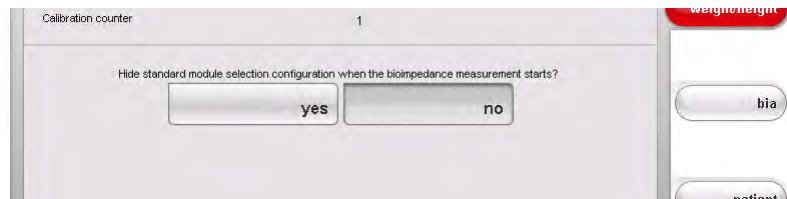

The verification counter reading (in this case: 1) is displayed.

4. Compare the content of the verification counter output with the number given on the verification counter sticker.

Both numbers have to match for the verification to be valid. If the sticker and the verification counter do not match, the scale must be subsequently verified. Please contact your service partner or seca service.

Once the scale has been subsequently verified, a new, updated verification counter sticker is used to identify the verification counter reader. The person authorized to perform the subsequent verification secures this sticker with an additional seal. The verification counter sticker can be ordered from seca service.

11. MAINTENANCE (UNVERIFIED MODEL)

On leaving the factory, your seca device has an accuracy of $\pm 0.15\%$ or better. To preserve this level of accuracy, the product must be set up with care and maintained on a regular basis.

The device's measurement technology for bioimpedance analysis (BIA) must be checked every two years. We recommend performing maintenance of the whole device as part of this check.

NOTICE!

Incorrect measurements as a result of poor servicing

- ▶ Please only have servicing and repairs performed by an authorized service partner.
- ▶ You can find service partners in your area at www.seca.com or by sending an e-mail to service@seca.com.

12. TROUBLESHOOTING

12.1 Power supply and display

Problem	Cause	Remedy
Device cannot be switched on	No power supply	Check whether power is being supplied
	Power pack faulty	Replace power pack with original part
Touchscreen display stays dark	Device on standby	<ul style="list-style-type: none"> • Touch the touchscreen display • Press the on/off button • Place a load on the device
	Device not switched on	Switch on device
	No power supply	Check whether power is being supplied
	Touchscreen display faulty	Inform seca service
Touchscreen display not reacting	Device in undefined state following implausible input	<ul style="list-style-type: none"> • Switch off the device (hold the on/off button for approx. 3 seconds) • Switch on the device again
Image on touchscreen display faulty	Touchscreen display faulty	Inform seca service

12.2 Height and weight

Problem	Cause	Remedy
0.00 does not appear before weighing	Device had load on it before it was switched on	<ul style="list-style-type: none"> • Remove the load from the device • Switch off the device, then switch back on again
The STOP message appears	Maximum load exceeded	Remove the load from the device
TEMP message appears	Ambient temperature too high or too low	<ul style="list-style-type: none"> • Set up the device in an ambient temperature between +10 °C and +40 °C • Wait for around 15 minutes until the device has adapted to ambient temperature
The message ER11 appears	Device overloaded as a whole or in one corner	<ul style="list-style-type: none"> • Remove the load or distribute the load evenly • Restart the device
The message ER12 appears	Device switched on with too heavy a load	<ul style="list-style-type: none"> • Remove the load from the device • Restart the device
The message ER16 appears	Natural vibration has been induced in device, zero point could not be determined	<ul style="list-style-type: none"> • Restart the device • Restart measurement

12.3 Bioimpedance analysis

Problem	Cause	Remedy
bia tab activated, but module selection does not appear	Module selection deactivated	Check setting and change if necessary (see “Adapting default module selection for bioimpedance analysis” on page 61)
Not all modules activated in module selection	Default module selection specified in which some modules are deactivated	<ul style="list-style-type: none"> • Activate missing modules directly in the module selection and perform the measurement • Adapt default module selection (see “Creating default module selection” on page 62)
The following message appears: “Electrode detection failed.”	Patient’s skin too dry	Spray the skin with electrode spray at the contact points
	Patient’s skin too calloused	Spray the skin with electrode spray at the contact points
	Electrodes faulty	Inform seca service
No PAL value can be entered after bioimpedance measurement	Energy evaluation module deactivated	<ul style="list-style-type: none"> • If the Energy evaluation module is not required, continue and complete measurement • If the Energy evaluation module is required, activate the evaluation module (see “Checking module selection” on page 31 or “Creating default module selection” on page 62)
No waist circumference can be entered following bioimpedance measurement	Health risk evaluation module deactivated	<ul style="list-style-type: none"> • If the Health risk evaluation module is not required, continue and complete measurement • If the Health risk evaluation module is required, activate the evaluation module (see “Checking module selection” on page 31 or “Creating default module selection” on page 62)
Results of bioimpedance measurement deviate significantly from expected results	Patient moved during the measurement	Request that the patient does not move during the measurement and repeat the measurement
	Patient used different pairs of hand electrodes on the left and right	Ensure that the patient uses the same hand electrodes on both sides and repeat the measurement
	Electrodes faulty	Inform seca service
Value of an evaluation parameter is shown in red	Value outside the normal range determined for the evaluation parameter	<ul style="list-style-type: none"> • Repeat the measurement in order to exclude measurement errors • If the repeat measurement also produces a value outside the normal range, take the value into account in further investigations
After a different tab has been called up temporarily, the assigned seca patient file is no longer shown in the patient tab	seca patient file selected, but selection not confirmed	Re-assign seca patient file and press the confirm button (see “Assigning a measurement to a patient file” on page 36), only then call up another tab

12.4 Data transmission

Problem	Cause	Remedy
Data transmission between device and seca 115 cannot be set up	Software versions incompatible	Administrator: use compatible software version: <ul style="list-style-type: none"> • device: min. software version 1.1 • PC software: min. software version 1.4
A seca patient file is shown as "not assigned" in the seca 115 PC software following import from a USB memory stick	USB PIN of the USB memory stick used for access to the seca patient database of the USB memory stick	<ul style="list-style-type: none"> • Manually assign current seca patient file to an attending physician in seca 115 • To import other patient files, use user PIN to access the seca patient database of the USB memory stick
seca patient file cannot be found when searching for a patient on the device	No seca patient file set up yet	Create a seca patient file (see "Creating a new seca patient file" on page 40)
	seca patient file is not yet assigned to you in the seca 115	Check whether or not the seca patient file can be assigned to you in the seca 115 .
	Port blocking of Windows firewall active, ports used for communicating with device being blocked	Administrator: release the ports used for communication with the device in Windows firewall
Patient name cannot be entered in the set dialog language	No keypad available for set dialog language	<ul style="list-style-type: none"> • Provide the seca patient file from the PC software (see "Providing a seca patient file from the PC software" on page 39) • Administrator: check whether the settings for region and language are correct.
seca patient file cannot be provided from the PC software	Function not available via seca 360° wireless network, no network connection established via Ethernet	Administrator: establish Ethernet connection
No access to seca patient database of the seca 115 PC software	No seca 360° wireless network established between the device and the PC on which the seca 115 PC software is installed	Administrator: set up the seca 360° wireless network
	No Ethernet connection established between the device and the PC on which the seca 115 PC software is installed	Administrator: establish Ethernet connection
	Device connected to a standalone PC via Ethernet cable, PC network card does not allow automatic crossover	Administrator: use a crossover adapter (see "Technical data" on page 71)
	No USB memory stick connected to the touchscreen display	Connect USB memory stick to the touchscreen display
	The PC on which the seca 115 PC software is installed has not been switched on.	Switch on the PC and start the seca 115 PC software
	seca 115 PC software not started	Start the seca 115 PC software
USB memory stick connected to touchscreen display but no access to the seca patient database	Non-initialized USB memory stick being used	<ul style="list-style-type: none"> • Use the USB memory stick supplied • Administrator: initialize USB memory stick using the seca 115 PC software
	PIN not entered or entered incorrectly	Use your user PIN or the USB PIN for the USB memory stick
	Unsuitable USB memory stick being used	<ul style="list-style-type: none"> • Use the USB memory stick supplied • Use a FAT16 USB memory stick
	Problem due to HF emissions from other devices (e.g. cellphones)	Increase distance from HF devices

12.5 Printing

Problem	Cause	Remedy
Print function not available	Software versions incompatible	Administrator: use compatible software version: <ul style="list-style-type: none"> • device: min. software version 1.1 • PC software: min. software version 1.4
Results report not being printed	PC printer not switched on	Switch on PC printer
	The PC on which the seca 115 PC software is installed has not been switched on.	Switch on PC
	No network connection established between device and seca 115 PC software	Administrator: establish Ethernet connection
	No connection established between seca 115 PC software and PC printer	Administrator: establish connection between seca 115 PC software and PC printer
No personal data in results report	On repeat measurement: no seca patient file assigned	Call up patient tab and assign seca patient file (see "Searching for a seca patient file" on page 37)
	On initial measurement: seca patient file not created yet	Call up patient tab and create seca patient file (see "Creating a new seca patient file" on page 40)
No bioimpedance parameters in results report	No bioimpedance measurement performed	Call up the bia tab and perform the measurement (see "Performing a bioimpedance measurement" on page 31)
No height in results report	No height entered on device	Call up the weight/height tab and enter height (see "Entering height manually" on page 29)
	No height transmitted by the seca 360° length measuring device	Measure the height of the patient again, then press the send/print button on the length measuring device (see "Transmitting height via seca 360° wireless network" on page 29)

13. TECHNICAL DATA

13.1 General technical data

General technical data	
Measurements • Depth • Width • Height	828 mm 976 mm 1251 mm
Net weight	approx. 36 kg
Ambient conditions, operation • Temperature • Air pressure • Humidity	+10 °C to +40 °C (50 °F to 104 °F) 700 hPa - 1060 hPa 30 % - 80 %, no condensation
Ambient conditions, storage • Temperature • Air pressure • Humidity	-10 °C to +65 °C (14 °F to 149 °F) 700 hPa - 1060 hPa 0 % - 95 %, no condensation
Ambient conditions, transport • Temperature • Air pressure • Humidity	-10 °C to +65 °C (14 °F to 149 °F) 700 hPa - 1060 hPa 0 % - 95 %, no condensation
Setup location, maximum altitude above mean sea level	3000 m
Display type	8.4" touchscreen display, can be swiveled 180° to the left and right
Power supply	Power pack
Mains voltage	100 V - 240 V
Mains frequency	50 Hz - 60 Hz
Power consumption • Standby (touchscreen display off, on/off button green) • In operation (no bioimpedance measurement, on/off button white) • In operation (bioimpedance measurement in progress, on/off button white)	< 2.7 W < 6.6 W < 15 W
Medical device in accordance with Directive 93/42/EEC	Class IIa
EN 60601-1: • Insulated device, protection class II • Medical electrical device, type BF	
seca 360° wireless network: • frequency band • transmission power	2.433 GHz - 2.480 GHz < 10 mW
Interfaces: • touchscreen display • weighing platform	USB 2.0 Ethernet (10/100 Base-T)
USB memory stick requirements: • Minimum disk space requirements • File system	2 GB FAT 16
Compatible printer	Microsoft® Windows®-compatible printer via seca 115 PC software

13.2 Technical data, bioimpedance analysis

Technical data, bioimpedance analysis	
Measuring method	8-point bioimpedance analysis
Electrode type	Stainless steel, 2 x 3 pairs of hand electrodes, 2 pairs of foot electrodes
Measuring frequencies	1; 1.5; 2; 3; 5; 7.5; 10; 15; 20; 30; 50; 75; 100; 150; 200; 300; 500; 750; 1000 kHz
Measured values	Impedance (Z), resistance (R), reactance (X _c), phase angle (φ)
Impedance measuring range	10 Ω to 1000 Ω
Measuring segments	Right arm, left arm, right leg, left leg, right side of body, left side of body, torso
Measuring current	100 μ (+20 %, -50 %)
Measurement duration: frequencies 5 kHz and 50 kHz all frequencies (only if Raw data for impedance module active)	max. 20 s max. 90 s
Accuracy at frequencies 5 kHz and 50 kHz Segments: right side of body, left side of body • Impedance (at phase angle 0°) • Phase angle (at phase angle 0°, impedance 200 Ω to 1000 Ω)	±5 Ω 0.5°
Evaluation parameters	See "Evaluation parameters" from page 47

Measure of certainty (R ²) and standard deviation (SEE) for predictive formulas in this device ^a										
Parameter	Ethnicity: Caucasian		Ethnicity: African-American		Ethnicity: Asian		Ethnicity: South/Central American		Ethnicity: other	
	R ²	SEE	R ²	SEE	R ²	SEE	R ²	SEE	R ²	SEE
FFM	0.96	2.17 kg	0.95	2.41 kg	0.95	1.92 kg	0.95	1.85 kg	0.96	2.07 kg
TBW	0.95	1.8 l	0.97	1.4 l	0.96	1.3 l	0.95	1.3 l	0.96	1.4 l
ECW	0.84	1.1 l	0.90	0.8 l	0.91	0.7 l	0.90	0.7 l	0.90	0.8 l
SMM left arm	0.88	0.18 kg	0.81	0.27 kg	0.82	0.19 kg	0.89	0.14 kg	0.86	0.2 kg
SMM right arm	0.85	0.21 kg	0.80	0.26 kg	0.83	0.18 kg	0.90	0.13 g	0.86	0.20 kg
SMM left leg	0.55	0.78 kg	0.73	0.70 kg	0.37	0.75 kg	0.25	0.74 kg	0.64	0.74 kg
SMM right leg	0.70	0.66 kg	0.80	0.6 kg	0.60	0.63 kg	0.50	0.63 kg	0.75	0.63 kg
SMM total	0.89	2.0 kg	0.90	2.2 kg	0.85	2.0 kg	0.88	1.8 kg	0.90	2.0 kg
VAT	0.89	0.5 l	0.61	0.7 l	0.71	0.6 l	0.54	1.2 l	0.75	0.8 l

a. In the USA, a study was conducted with 130 healthy adults of different ethnicities. The aim of the study was to validate the parameters determined using seca formulas against clinically established reference methods. The results of this comparative study are shown in the table above. The table shows the degree of certainty (R²) and standard deviation (SEE) for the parameters determined using seca's formulas by ethnicity.

13.3 Weighing data (verified model)

seca 515	
Accuracy class in accordance with Directive 2014/31/EU	III
Measuring method	4 load cells
Maximum load <ul style="list-style-type: none"> • Partial weighing range 1 • Partial weighing range 2 	150 kg 300 kg
Minimum load <ul style="list-style-type: none"> • Partial weighing range 1 • Partial weighing range 2 	1 kg 2 kg
Increments <ul style="list-style-type: none"> • Partial weighing range 1 • Partial weighing range 2 	50 g 100 g
Tare range	to 300 kg
Accuracy on initial verification <ul style="list-style-type: none"> • Weighing range 1: 0 to 25 kg • Weighing range 1: 25 kg to 100 kg • Weighing range 1: 100 kg to 150 kg • Weighing range 2: 0 to 50 kg • Weighing range 2: 50 kg to 200 kg • Weighing range 2: 200 kg to 300 kg 	±25 g ±50 g ±75 g ±50 g ±100 g ±150 g

13.4 Weighing data (unverified model)

seca 514	
Measuring method	4 load cells
Maximum load <ul style="list-style-type: none"> • Partial weighing range 1 • Partial weighing range 2 	150 kg / 330 lbs / 24 sts 300 kg / 660 lbs / 47 sts
Minimum load <ul style="list-style-type: none"> • Partial weighing range 1 • Partial weighing range 2 	1.0 kg 2.0 kg
Increments <ul style="list-style-type: none"> • Partial weighing range 1 • Partial weighing range 2 	50 g / 0.1 lbs 100 g / 0.2 lbs
Tare range	300 kg
Accuracy <ul style="list-style-type: none"> • 0 to 35 kg • 35 kg to maximum load • 0 to 75 lbs • 75 lbs to maximum load • 0 to 5.5 sts • 5.5 sts to maximum load 	±100 g ±0.3% ±0.2 lbs ±0.3% ±0.2 lbs ±0.3%

13.5 Technical modifications

Combination seca 515/514 (SW version 1.1) seca 115 (SW version 1.4)	
Downward-compatible:	no
New:	<ul style="list-style-type: none"> • regional settings: drop-down menus Name format, Name hyphen • enter waist circumference with Health risk evaluation module activated • visceral adipose fat (VAT) parameter in the Health risk evaluation module • skeletal muscle mass (SMM) parameter in the Function/rehabilitation evaluation module • send individual seca patient file from the seca 115 PC software to mBCA • start printing out results reports directly on device (seca 515/514)
Modified:	graphical representation: phase angle (ϕ), bioimpedance vector analysis (BIVA), body composition chart (BCC), total body water (TBW)
No longer applicable:	lean soft tissue (LST) parameter in Function/rehabilitation evaluation module

14. OPTIONAL ACCESSORIES

Accessory	Article number
Measuring stations <ul style="list-style-type: none"> • seca 285 • seca 284 	Country-specific versions Country-specific versions
Length measuring rods <ul style="list-style-type: none"> • seca 274 • seca 264 	Country-specific versions Country-specific versions
PC software <ul style="list-style-type: none"> • seca analytics 115 	Application-specific license packages
seca 360° wireless USB adapter 456 USB wireless adapter	456-00-00-009

15. SPARE PARTS

Spare parts	Article number
Power pack, Euro: 100-240 V~ / 50-60 Hz / 12 V= / 1.2 A	68-32-10-268
seca 201 circumference measuring tape	201-17-17-009
DVD with seca analytics 115 PC software and license for a permanent workplace	Country-specific versions
seca 360° wireless USB adapter 456	456-00-00-009
Ethernet cable (1.5 m)	08-06-16-467

16. DISPOSAL



Do not dispose of the device with your household waste. It has to be properly disposed of as electronic waste. Follow your respective national regulations. For more information, please contact our service representatives at:

service@seca.com

17. WARRANTY

There is a two-year warranty period from delivery for defects attributable to material or fabrication errors. All movable parts, including batteries, cables, power packs, rechargeable batteries etc. are exempt. Defects which come under the warranty will be repaired for the customer free of charge against proof of purchase. Additional claims cannot be considered. Costs of transport to and from seca are the responsibility of the customer if the device is located somewhere other than the customer's headquarters. In the event of transport damage, warranty claims can only be made if the complete original packaging was used for transport and the device was secured and fastened therein according to its originally-packed condition. You should therefore keep all packaging parts.

The warranty will be voided if the device is opened by persons not expressly authorized by seca to do so.

We ask customers overseas to contact the seller in their respective country directly in the event of warranty claims.

18. DECLARATION OF CONFORMITY

seca gmbh & co. kg hereby declares that the product meets the terms of the applicable European directives. The unabridged declaration of conformity can be found at: www.seca.com.

Medical Measuring Systems and Scales since 1840

seca gmbh & co. kg
Hammer Steindamm 3–25
22089 Hamburg · Germany
Telephone +49 40 20 00 00 0
Fax +49 40 20 00 00 50
info@seca.com

seca operates worldwide with headquarters
in Germany and branches in:

seca france

seca united kingdom

seca north america

seca schweiz

seca zhong guo

seca nihon

seca mexico

seca austria

seca polska

seca middle east

seca brasil

seca suomi

seca américa latina

and with exclusive partners in
more than 110 countries.

All contact data under www.seca.com